

**CODE OF
PRACTICE
FOR
ROAD SIGNS**

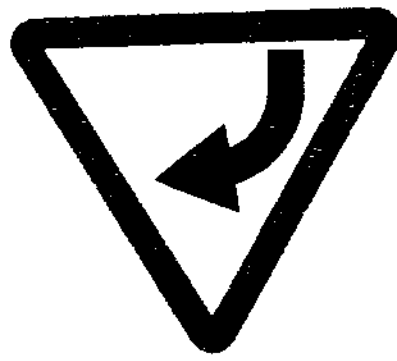

CODE OF PRACTICE FOR ROAD SIGNS

Published by
THE INDIAN ROADS CONGRESS
Jammagar House, Shahjahan Road,
NEW DELHI - 110 011
2001

Price Rs.500/-
(plus packing & postage)

First Published : March, 1978
Reprinted : 1989
Reprinted : 1998
First Revision : July, 2001

(Rights of Publication and Translation are Reserved)

Printed at Nutan Printers, New Delhi-110020
(1000 copies)

CONTENTS

Personnel of the Highways Specifications and Standards Committee	
1. Introduction	1
2. Classification of Road Signs	2
3. Siting of Signs with Respect to the Carriageway	2
4. Orientation of the Signs	3
5. Material for Signs	3
6. Posts and Mountings for Signs	6
7. Colour for Signs	6
8. Sizes of Signs	7
9. Visibility of Signs	7
10. Sizes of Letters	7
11. Maintenance of Signs	8
12. Definition Plates/Supplementary Plates	8
13. Mandatory/Regulatory Signs	8
14. Cautionary/Warning Signs	13
15. Informatory Signs	20
ANNEXURES	
1. List of Mandatory/Regulatory Signs	24
2. List of Cautionary/Warning Signs	25
3. List of Informatory Signs	26
4. Rules for the Design of Informatory Road Signs	27
PLATES	
1. Mandatory/Regulatory Signs	37
2. Cautionary/Warning Signs	55
3. Informatory Signs	79

PERSONNEL OF THE HIGHWAYS SPECIFICATIONS AND STANDARDS COMMITTEE

(As on 21.12.1999)

1. Director General (Road Dev.) & Addl. Secy. to the Govt. of India, Ministry of Road Transport & Highways, Transport Bhawan, New Delhi-110001.
2. C.C. Bhattacharya (Member-Secretary)
3. M.K. Agarwal
4. D.N. Banerjee
5. Dr. O.P. Bhatta
6. Dr. A.K. Bhanuagar
7. D.P. Gupta
8. Kam Babu Gupta
9. H.P. Jandara
10. Prof. C.E.G. Justice
11. Dr. L.R. Kadiyali
12. Kushan Kant
13. R.L. Koul
14. J.B. Mathur
15. S.C. Pandey
16. M.V. Pathi
17. K.B. Rajona
18. Prof. N. Ranganathan
19. Prof. Gopal Kanjan
20. Prof. G.V. Rao
21. V. Murahari Reddy
22. K.K. Sarm
23. Prof. P.K. Sikdar
24. Nirmaljit Singh

MEMBERS

1. Chief Engineer (R), S&R, Ministry of Road Transport & Highways, Transport Bhawan, New Delhi-110001.
2. Dy. Director & Head, Civil Engg. Department, G.S.I.T.S., H-55, M.I.G., Indore-452008.
3. Director, Indian Oil Corporation Ltd., Scope Complex, Core-II, Lodhi Road, New Delhi-110003.
4. DG(RD), MOST (Reid), F-44, Greater Kailash (Part-I) Enclave, New Delhi-110048.
5. Chief Engineer (Mech.), Rajasthan Public Works Department, B&R, Jaipur.
6. Principal Secretary to the Govt. of Gujarat, R&B Department, Sardar Bhawan, Block No.14, Sachivalaya, Gandhinagar-382010.
7. Emeritus Fellow, 334, 25th Cross, 14th Main, Banashankar 2nd Stage, Bangalore-560070.
8. Chief Consultant, Dr. L.R. Kadiyali & Associates, C-6/7, III Floor, Sardarjung Development Area, Hauz Khas, New Delhi-110016.
9. Chief Engineer (B) S&R, Ministry of Road Transport & Highways, Transport Bhawan, New Delhi-110001.
10. Member, National Highways Authority of India, 1, Eastern Avenue, Mahatma Bagh, New Delhi-110065.
11. Chief Engineer (Planning), Ministry of Road Transport & Highways, Transport Bhawan, New Delhi-110001.
12. Secretary to the Govt. of Madhya Pradesh, Public Works Department, Mantralaya, Bhopal-462004.
13. Secretary (Roads), P.W.D., Mantralaya, Mumbai-400032.
14. Engineer-in-Chief, P.W.D., Govt. of Delhi, K.G. Marg, New Delhi-110001.
15. Head of Dept. of Transportation Pkg. SPA (Reid) Consultant, 458, C.S.F.S., Sheikh Sarai I, New Delhi-110017.
16. Director, College of Engineering, Roorkee, 27, 7th KM, Roorkee-Hardwar Road, Vardhman Puram, Roorkee-247667.
17. Deputy of Civil Engg., IIT, Hauz Khas, New Delhi-110016.
18. Engineer-in-Chief, R&B Department, A&E, Forum Manzil, Hyderabad-500082.
19. DC(RD) & AS, MOST (Reid), S-108, Panchsheel Park, New Delhi-110017.
20. Director, Central Road Research Institute, P.O. C.R.R.I., Delhi-Mathura Road, New Delhi-110020.
21. Chief Engineer (T&T), Ministry of Road Transport & Highways, Transport Bhawan, New Delhi-110001.

* ADC(B) being not in position, the meeting was presided by Shri Prafulla Kumar, DG(RD) & Addl. Secretary to the Govt. of India, MORT&H

25. Prof. A.K. Sharma
Head of Deptt. of Transport Planning, School of Planning & Architecture, 4, Block B, I.P. Estate,
New Delhi-110002

26. R.K. Sharma
Engineer-in-Chief, Public Works Department, U.S. Club, Shimla-171001.

27. B.L. Tikoo
Addl. Director General, Directorate General Border Roads, Secma Sadak Bhawan, Ring Road,
New Delhi-110010.

28. Prof. C.G. Swaminathan
S.C. Sharma
'Badli', 6, Thiruvaynadam Street, R.A. Puram, Chennai-600025.

29. P.D. Wani
Chief Engineer, Ministry of Road Transport & Highways, Transport Bhawan, New Delhi-110001.

30. P.D. Wani
Member, Maharashtra Public Service Commission, 3rd Floor, Bank of India Building, M.G. Road,
Mumbai-400001

31. The Director General (Works)
Engineer-in-Chief's Branch, Army Hqrs., Kashmir House, DHQ P.O., New Delhi-110011

32. The Secretary to the
Govt. of Karnataka
PWD, Room No.610, 6th Floor, Multistoreyed Building, Dr. Ambedkar Road, Bangalore-560001.

33. The Engineer-in-Chief
Haryana Public Works Deptt., B&R, Sector-19-B, Chandigarh-160019.

34. The Chief Engineer
U.P. Public Works Department, National Highways, Lucknow-226001.

35. The Director & Head
Civil Engrg. Department, Bureau of Indian Standards, Manak Bhawan, 9, Bahadur Shah Zafar Marg,
New Delhi-110002.

36. The Chief Engineer
National Highways, Assam Public Works Department, Dispur, Guwahati-781006

37. The Director
Highways Research Station, 76, Sardar Patel Road, Chennai-600025

38. The President
K.H. Rajona
Indian Roads Congress

39. The Director General
Pratulla Kumar
Ministry of Road Transport & Highways, Transport Bhawan, New Delhi-110001.

40. The Secretary
S.C. Sharma
Chief Engineer, Ministry of Road Transport & Highways, Transport Bhawan, New Delhi-110001

38. The President
K.H. Rajona
Indian Roads Congress

39. The Director General
Pratulla Kumar
Ministry of Road Transport & Highways, Transport Bhawan, New Delhi-110001.

40. The Secretary
S.C. Sharma
Chief Engineer, Ministry of Road Transport & Highways, Transport Bhawan, New Delhi-110001

CORRESPONDING MEMBERS

1. Dr. Yudhvir
House No. 642, IIT Campus, P.O., IIT, Kanpur.

2. Dr. V.M. Sharma
Consultant, AMHL, Ltd., A-8, Mohan Cooperative Industrial Estate, Narney House, Mathura Road,
New Delhi-110044.

3. Dr. S. Raghava Chari
Emeritus Professor, IIT, IIT, No 16-11-20/5/5, Dilukhagar-3, Hyderabad-500036

4. N.V. Merani
(Past President, IRC), A-47, 1344, Adarshnagar, Worli, Mumbai-400025

1. INTRODUCTION

1.1. Traffic signs, which have the backing of law in India, are incorporated in Section 16 of the Indian Motor Vehicles Act, 1988.

1.2. The Motor Vehicles Act, 1988 has covered all the signs warranted by different traffic situations and the designs of signs fully dimensioned. Further the signs have the uniformity, and mostly symbols are used to convey the message, especially in the case of regulatory signs.

1.3. The existing road signs (IRC:67-1977) have been reviewed by the Traffic Engineering Committee of the Indian Roads Congress in the light of recommendations made by various international conventions, with a view to evolving a uniform and an efficient system of road signs suiting the present as well as future traffic. This Code of Practice sets out the methodology to be followed in the use, siting, construction and maintenance of the road signs for all categories of roads excepting for expressways, for which higher standards are required. The traffic signs adopted in this code are as proposed in Protocol on Road Signs and Signals of United Nations Conference on Road and Motor Transport, 1949 and Geneva Convention on Road Signs and Signals, 1968.

1.4. The draft revision of the Code of Practice prepared by Dr. T.S. Reddy was considered by the Traffic Engineering Committee (personnel given below) in their meeting held on the 22nd October, 1998 and it authorised the Convenor and Dr. T.S. Reddy to finalise the same and send to IRC for consideration by Highways Specifications and Standards Committee.

Nirmaljit Singh
S.K. Marwah
Convenor
Member-Secretary

MEMBERS

Dr. L.R. Kadiyali
Dr. P.S. Pasricha
Dr. T.S. Reddy
Prof. P.K. Sikdar
D. Sanyal
A.P. Bahadur
Dr. S. Vishwanath
Prof. A.K. Sharma
B.C. Datta

CO-OPTED MEMBER

M. Ganesan

CORRESPONDING MEMBERS

Prof. S. Raghavachari
Dr. B.K. Katti
Dr. A. Veeraragavan
P.P.S. Sawhney

The Highways Specifications & Standards Committee approved the draft in its meeting held on 21st December, 1999. Subsequently the draft was approved by Executive Committee on 10th February, 2000 and Council in its 159th meeting held at Pune on 26th May, 2000.

2. CLASSIFICATION OF ROAD SIGNS

Road Signs shall be classified under the following three heads:

- (i) **Mandatory/Regulatory Signs:** These signs are used to inform road users of certain rules and regulations to improve safety and free flow of traffic. These include all signs, such as, STOP, GIVE WAY, Speed Limits, No Entry, etc. which give notice of special obligations, prohibitions or restrictions with which the road users must comply. The violation of the rules and regulations conveyed by these signs is a legal offence.
- (ii) **Cautionary/Warning Signs:** These signs are used to caution the road users of the existence of certain hazardous conditions either on or adjacent to the roadway, so that the motorists can become cautious and take the desired action. Some examples of these signs are Hairpin Bend, Narrow Bridge, etc.
- (iii) **Informatory Signs:** These signs are used to provide information and to guide road users along routes. The information could include names of places, sites, direction to the destinations, distance to places, to make the travelling/driving easier, safer and pleasant.

3. SITING OF SIGNS WITH RESPECT TO THE CARRIAGEWAY

3.1. The Road signs are the means of communication to the road users, especially drivers. Therefore, the signs shall be so placed that the drivers can recognise them easily and in time. Normally the signs shall be placed on the left hand side of the road. For two-lane roads, normally the signs may be placed on the left side of the carriageway repeated on the other side of the carriageway if local conditions are such that the signs might not be seen in time by the drivers. In case of divided carriageway, signs may be placed on the median. In case of hill roads, the signs shall generally be fixed on the valley side of the road, unless traffic and road conditions warrant these to be placed on the hill side.

3.2. On kerbed roads, the extreme edge of the sign adjacent to the highway shall not be less than 60 cm away from the kerb line. On roads without kerb, the extreme edge of the sign adjacent to the highway shall be at the distance of 2 to 3 metres from the edge of the carriageway depending on local conditions but in no case shall any part of the sign come in the way of vehicular traffic.

3.3. On kerbed roads, the bottom edge of the lowest sign shall not be less than 2 metres and not more than 2.5 metres above the kerb. On roads without kerb, the bottom edge of the lowest sign shall not be less than 2 metres and not more than 2.5 metres above the crown of the pavement.

3.4. Where in the opinion of competent authorities a sign would be ineffective if placed on the left hand side shoulder of a road with dual carriageway, it may be placed on the median and in that case may not be repeated on the shoulder. To improve the visibility of the signs on multi-lane carriageway the minimum height of the lower edge of the sign should be kept as 3 metres above crown the highest point of the carriageway.

3.5. The signs shall be so placed that these do not obstruct vehicular traffic on the carriageway, and if placed on the shoulder/footpath/refuge island, obstruct pedestrians as far as possible. The difference in level between the lower edge of the sign and the carriageway shall be as uniform as possible for signs of the same class on the same route.

3.6. On multi-lane high speed roads, the signs may have to be mounted overhead, as this would ensure better visibility and be effective in communicating with the drivers. For guidelines on location, design and installation of overhead signs, reference may be made to MOST Specifications for Road and Bridge works (Section 802). The overhead signs shall be mounted to ensure better visibility and effective in communicating the drivers in the following cases:

- ✓ Traffic volume at or near capacity
- ✓ Complex interchange design
- ✓ Three or more lanes in each direction
- ✓ Restricted sight distance
- ✓ High speed traffic
- ✓ Insufficient space for ground mounted signs

Overhead signs shall provide a vertical clearance of not less than 5.5 metres over the entire width of pavement and shoulders except where a lesser vertical clearance is used for the design of other structures.

4. ORIENTATION OF THE SIGNS

4.1. The signs shall normally be placed at right angles to the line of travel of the approaching traffic. Signs relating to parking, however, should be fixed at an angle (approximately) 15 degrees to the carriageway so as to give better visibility.

4.2. Where light reflection from the sign face is encountered to such an extent as to reduce legibility, the sign should be turned slightly away from the road. On horizontal curves, the sign should not be fixed normal to the carriageway but the angle of placement should be determined with regard to the course of the approaching traffic.

4.3. Sign faces are normally vertical, but on gradients it may be desirable to tilt a sign forward or backward from the vertical to make it normal to the line of sight and improve the viewing angle.

5. MATERIAL FOR SIGNS

The various materials and fabrication of traffic signs shall conform to the following requirements:

5.1. Concrete: Concrete shall be of M150 grade (mix 1:2:4).

5.2. Reinforcing Steel: Reinforcing steel shall conform to the requirements of IS:1786 unless otherwise specified.

5.3. Bolts, Nuts, Washers: High strength bolts shall conform to IS:1367 whereas precision bolts, nuts, etc. shall conform to IS:1364.

5.4. Plates and Supports: Plates and support sections for the signposts shall conform to IS:226 and IS:2062 or any other stated IS specification.

5.5. **Aluminium:** Aluminium sheets used for sign boards shall be of smooth, hard and corrosion resistant aluminium alloy conforming to IS:736 - Material Designation 24345 or 1900.

5.6. **Plate Thickness:** Signs with a maximum side dimension not exceeding 600 mm shall not be less than 1.5 mm thick. All other signs shall be at least 2 mm thick. The thickness of the sheet shall be related to the size of the sign and its support and shall be such that it does not bend or deform under prevailing wind and other loads.

5.7. For lower category roads, other suitable local materials, such as, timber planks with metal lining may be used.

5.8. **Retro-reflective Sheeting:** The retro-reflective sheeting used on the signs shall consist of the white or coloured sheeting having a smooth outer surface which has the property of retro-reflection over its entire surface. It shall be weather resistant and exhibit colourfastness. It shall be new and unused and shall show no evidence of cracking, scaling, pitting, blistering, edge lifting or curling and shall have negligible shrinkage or expansion. The reflective sheeting can be either of Engineering Grade material with enclosed lens or High Intensity Grade with encapsulated lens. The type of the sheeting to be used would be dependent upon the type, functional hierarchy and importance of the road.

5.8.1. **High intensity grade sheeting:** This sheeting shall be of encapsulated lens type consisting of spherical glass lens, elements adhered to a synthetic resin and encapsulated by a flexible, transparent waterproof plastic has a smooth surface. The retro-reflective surface after cleaning with soap and water and in dry condition shall have the minimum co-efficient of retro-reflection (determined in accordance with ASTM Standard E:810) as indicated in Table 5.1.

Table 5.1. Acceptable Minimum Co-efficient of Retro-Reflection for High Intensity Grade Sheeting (Candelas per Lux per Square Metre)

Observation angle in degrees	Entrance angle in degrees	White	Yellow	Orange	Green/Red	Blue
0.2	-4	250	170	100	45	20
0.2	-30	150	100	60	25	11
0.5	-4	95	62	30	15	7.5
0.5	-30	65	45	25	10	5.0

When totally wet, the sheeting shall not show less than 90 per cent of the values of retro-reflectance indicated in Table 5.1. At the end of 7 years, the sheeting shall retain at least 75 per cent of its original retro-reflectance.

5.8.2. **Engineering grade sheeting:** This sheeting shall be of enclosed lens type consisting of microscopic lens elements embedded beneath the surface of a smooth, flexible, transparent, water-proof plastic, resulting in a non-exposed lens optical reflecting system. The retro-reflective surface after cleaning with soap and water and in dry condition shall have the minimum co-efficient of retro-reflection (determined in accordance with ASTM Standard: E-810) as indicated in Table 5.2.

5.9. Messages/Borders: The messages (legends, letters, numerals, etc.) and borders shall either be screen-printed or of cut-outs. Screen printing shall be processed and finished with materials and in a manner specified by the sheeting manufacturer and shall be bonded with the sheeting in the manner specified by the manufacturer.

Complete sheets of the material shall be used on the signs except where it is unavoidable. At splices, sheeting with pressure-sensitive adhesives shall be overlapped not less than 5 mm. Sheeting with heat-activated adhesives may be spliced with an overlap not less than 5 mm or butted with a gap not exceeding 0.75 mm. Where screen printing with transparent colours is proposed, only butt joining shall be used. The material shall cover the sign surface evenly and shall be free from twists, cracks and folds. Cut-outs to produce legends and borders shall be bonded with the sheeting in the manner specified by the manufacturer.

5.8.4. Fabrication: Surface to be reflectorised shall be effectively prepared to receive the retro-reflective sheeting. The aluminium sheeting shall be de-greased either by acid or hot alkaline etching and all scale/dust removed to obtain a smooth plain surface before the application of retro-reflective sheeting. If the surface is rough, approved surface primer may be used. After cleaning, metal shall not be handled, except by suitable device or clean canvas gloves, between all cleaning and preparation operation and application of reflective sheeting/primer. There shall be no opportunity for metal to come in contact with grease, oil or other contaminants prior to the application of retro-reflective sheeting.

5.8.3. Adhesives: The sheeting shall either have a pressure-sensitive adhesive of the aggressive-lack type requiring no heat, solvent or other preparation for adhesion to a smooth clean surface, or a tack free adhesive activated by heat, applied in a heat-vacuum applicator, in a manner recommended by the sheeting manufacturer. The adhesive shall form a durable bond to smooth, corrosion and weather resistant surface of the base plate such that it shall not be possible to remove the sheeting from the sign base in one piece by use of sharp instrument. In case of pressure-sensitive adhesive sheeting, the sheeting shall be applied in accordance with the manufacturer's Specifications. Sheeting with adhesives requiring use of solvents or other preparation for adhesive shall be applied strictly in accordance with the manufacturer's instructions.

When totally wet, the sheeting shall not show less than 90 per cent of the values of retro-reflection indicated in Table 5.2. At the end of 5 years, the sheeting shall retain at least 50 per cent of its original retro-reflectance.

Observation angle in degrees	Entrance angle in degrees	White	Yellow	Orange	Green	Red	Blue
0.2	- 4	70	50	25	9.0	14.5	4.0
0.2	+30	30	22	7.0	3.5	6.0	1.7
0.5	- 4	30	25	13.5	4.5	7.5	2.0
0.5	-30	15	13	4.0	2.2	3.0	0.8

Table 5.2. Acceptable Minimum Co-efficient of Retro-Reflection for Engineering Grade Sheeting (Candelas per Lux per Square Metre)

For screen-printed transparent coloured areas on white sheeting, the co-efficient of retro-reflection shall not be less than 50 per cent of the values of corresponding colour in Tables 5.1 and 5.2 as applicable. Cut-out messages and borders, wherever used, shall be made out of retro-reflective sheeting (as per Clause 5.8.1 or 5.8.2 as applicable), except those in black which shall be of non-reflective sheeting.

6. POSTS AND MOUNTINGS FOR SIGNS

In case of signs supported on two or more posts if necessary bracing may also be provided. Sign posts, their foundations and sign mountings shall be so constructed as to hold these in a proper and permanent position against the normal storm wind loads or displacement by vandalism. Normally, signs with an area upto 0.9 sq.m. shall be mounted on a single post, and for greater area two or more supports shall be provided. Sign supports may be of mild steel, reinforced concrete or galvanised iron (G.I. Post) sections. End(s) shall be firmly fixed to the ground by means of properly designed foundation. The work of foundation shall conform to relevant Specifications as specified.

All components of signs and supports, other than the reflective portion of G.I. posts shall be thoroughly descaled, cleaned, primed and painted with two coats of epoxy paint. Any part of mild steel (M.S.) post below ground shall be painted with three coats of red lead paint.

The signs shall be fixed to the posts by welding in the case of steel posts and by bolts and washers of suitable size in the case of reinforced concrete or G.I. posts. After the nuts have been tightened, the tails of the bolts shall be furred over with a hammer to prevent removal.

7. COLOUR FOR SIGNS

7.1. Signs shall be provided with retro-reflective sheeting or painted in colours as shown on the detailed drawings. The reverse side of all sign shall be painted grey.

7.2. Except in the case of level crossing signs (for which the colour scheme is given later) the sign posts shall be painted in 25 cm wide bands, alternately black and white. The lowest band next to the ground shall be in black.

7.3. Colours shall comply with the following I.S.I shades given in Bureau of Indian Standards (B.I.S.): 5-1978 "Colours for Ready Mixed Paints":

- Blue - Indian Standard Colour No.166 : French Blue
- Red - Indian Standard Colour No.537 : Signal Red
- Grey - Indian Standard Colour No.630 : French Grey
- Green - Indian Standard Colour No.284 : India Green

7.4. The mandatory and warning signs shall be provided with white background and red border. The legend/a symbol for these signs shall be in black colour.

7.5. The colours chosen for informatory or guide signs shall be distinct for different classes of roads. For National Highways and State Highways, these signs shall be of green background with white borders, legends and word messages. For all other roads, like, MDRs, ODRs, Village Roads, these signs shall be of white background with black borders, legends and word messages.

10.3. For advance direction signs on rural roads, the letter size ('x' height) should be minimum of 15 cm for National and State Highways and 10 cm for other roads. In case of overhead signs, the size ('x' height) of letters may be minimum 30 cm. Thickness of the letter could be varied from 1/6 to 1/5 of the letter 'x' size. The size of the initial upper case letter shall be $1\frac{1}{3}$ times x-height. In urban areas, letter size shall be 10 cm on all directional signs for easy and better comprehension the word messages shall be written in initial upper case letter followed by lower case letters.

Design Speed the Highway (kmph)	Minimum 'x' Height of the Letter (cms)	Minimum Sighting Distance (m)	Maximum Distance from Centre Line (m)
120	20.0	115	32
90	15.0	90	24
80	12.5	80	21
60	10.0	60	16
45	7.5	45	12

Table 10.1 . Acceptable Limits for Size of Letters

10.2. Letter size should be chosen with due regard to the speed, classification and location of the road, so that the sign is of adequate size for legibility but without being too large or obtrusive. The size of the letter, in terms of x-height, to be chosen as per the design speed are given in Table 10.1.

10.1. The size and shape of letters and their interspacing and numerals used on informative signs or definition plates shall be as detailed in IRC:30-1968 "Standard Letters and Numerals of Different Heights for use on Highway Signs".

10. SIZES OF LETTERS

In order to make them more visible and legible at night, in particular danger/warning signs and regulatory signs other than those regulating parking and stopping in lighted streets or built-up areas, shall be lighted or provided with reflective material including luminous paints or reflective devices. Care should, however, be taken that this does not result in road users becoming dazzled.

9. VISIBILITY OF SIGNS

8.2. General dimensions of different categories of signs are given in respective sections.

8.1. As a general rule, there shall be two sizes of signs for mandatory/regulatory and cautionary/warning signs. The normal size shall be used for main roads in rural areas, and the small size shall be used for less important roads in rural areas and all the roads in urban areas. For certain categories of mandatory/regulatory signs, a still smaller size may be used in conjunction with traffic light signals or on bollards on traffic islands.

8. SIZES OF SIGNS

10.4. Letter size on definition plates attached with normal sized signs should be 10 or 15 cm. In the case of small signs, it should be 10 cm. Where the message is long, as for instance in "NO PARKING" and "NO STOPPING" signs the message may be broken with two lines and the size of letters may be varied in the lines so that the definition plate is not too large. The lettering on definition plates will be all in upper case letters.

11. MAINTENANCE OF SIGNS

The signs alongwith the posts shall be maintained in proper position, and kept clean and legible at all times. Damaged signs shall be replaced immediately. All signs shall be inspected atleast twice a year both in day and night times and atleast once a year in the rain. The authorities responsible for road signs should maintain a schedule of painting of the posts and signs periodically. It is recommended that painting the signs (where applicable) and may be undertaken after every two years. In case of overhead signs, adequate provision be made to have access to the signs for the purpose of maintenance activities. This must be ensured at the time of installation. Special care shall be taken to see that weeds, shrubbery, mud, etc. are not allowed to obscure any sign.

12. DEFINITION PLATES/SUPPLEMENTARY PLATES

Where the competent authority considers it advisable to make the meaning of a sign or symbol more explicit, or in the case of mandatory signs to limit their application to certain categories of road users or to specific periods, an inscription shall be placed below the sign in a rectangular definition plate of suitable size. The definition plate shall have white background and black letters and black border 20 mm wide. Numerals shall be inscribed in international form of Indian numerals and word messages shall be in English and/or other languages as necessary. To contain the size of the sign, the number of languages on the signs shall be limited to two.

13. MANDATORY/REGULATORY SIGNS

13.1. The detailed dimensioned drawings of normal sized sign and symbols thereon are shown in *Plate-1* for ease of reproduction. For signs of other sizes, the symbols should be proportionately reduced or enlarged. The mandatory/regulatory signs are listed in *Annexure-1*. These are classified under the following sub-heads keeping in view their design and application:

- (i) 'Stop' and 'Give Way' signs
- (ii) 'Prohibitory' signs
- (iii) 'No Parking' and 'No Stopping' signs
- (iv) 'Speed Limit' and 'Vehicle Control' signs
- (v) 'Restriction Ends' sign, and
- (vi) 'Compulsory Direction Control' and other signs

13.2. Stop sign

13.2.1.1. Purpose: The sign is intended for use on roadways where traffic is required to stop before entering a major road, and where it is intended that the vehicle shall proceed past the stop line only after ascertaining that this will not cause danger to traffic on the main road.

13.2.1.2. **Combination with markings:** The stop sign shall always be used in combination with certain road markings, such as, stop line and the word "STOP" marked on the pavement wide IRC:35-1997 "Code of Practice for Road Markings".

13.2.1.3. **Size, shape and colour:** The sign (shown in Fig. 13.1) shall be octagonal in shape and shall have red background and white border. The word "STOP" written in white (in English or local language) with 150 mm height letters, centrally positioned. The height of the octagon shall be 90 cm including the border for normal sized sign and 60 cm including the border for small sized sign. The width of the border shall be 30 mm and 20 mm respectively.

13.2.1.4. **Warrants for installation:** The sign should be used on a minor road at its intersection with a major road where conditions are considered to be unduly hazardous due to restricted visibility, bad alignment, high accident record, etc. making it imperative for the minor road traffic to stop on every occasion. The sign may also be used at other inter-sections where a combination of high speed, restricted view and record of serious accidents indicates the need for control by stop sign. The sign should not be used at inter-sections where traffic signals are installed or where traffic is controlled by traffic police. The stop sign is not to be used for speed control.

13.2.1.5. **Location:** Stop signs should be sited as close to the stop line as possible but not in such a position as to impair visibility along the major road. Normally, these should be fixed 1.5 to 3 metres in advance of the stop line. If the site conditions prevent a sign so placed from being easily seen, it should be placed at a greater distance in advance of the STOP line, but not more than 6 metres from it.

13.2.2. Give way sign

13.2.2.1. **Purpose:** The sign is used to assign right-of-way to traffic on certain roadways and inter-sections, the intention being that the vehicles controlled by the sign must give way to other traffic having the right-of-way.

13.2.2.2. **Size, shape and colour:** The sign (shown in Fig. 13.2) shall be an equilateral triangle with the apex downwards. It shall have red border and white background. The side of the normal sized sign shall measure 90 cm including the border; the side of the small sized sign shall measure 60 cm including the border. The size of the border shall be 70 mm and 45 mm respectively. Message GIVE WAY written in black letters of 150 mm height letters as shown in the diagram in appropriate language.

13.2.2.3. **Warrants for installation:** The sign shall be used on a minor road at the entrance to an inter-section where it is necessary to assign right-of-way to the major road but where a stop is not necessary at all times. The sign shall also be used on hill roads with single or intermediate lane carriageway on long gradients facing the downhill traffic to assign right-of-way to vehicles climbing uphill. 13.2.2.4. **Location:** The sign should be located in advance to the point where vehicles are required to stop to yield the right-of-way, say at a distance of 25 to 50 metres. It is also recommended that Give Way line (Ref. IRC:35-1997) should be marked at the entry to the junction. Give way line may be preceded by give way marking on the road. On gradients, the sign should be placed at the start of the down gradient and repeated as necessary.

13.3. Prohibitory Signs (Figs. 13.3 to 13.19)

13.3.1. **Size, shape and colour:** The signs shall be of circular shape with a red border, white background, and black symbol. Their diameter shall be 90 cm in case of normal sized signs and 60 cm in the case of small sized signs. Width of the border shall be 75 mm and 50 mm.

A smaller size of 30 cm diameter may be used in conjunction with traffic light signals or on bollards on traffic islands. Widths of the border in that case shall be 35 mm.

13.3.2. **Straight prohibited/no entry:** The signs shall be located at places where the vehicles are not allowed to enter. It is generally erected at the end of one-way road to prohibit traffic entering the roadway in the wrong direction and also at each intersection along the one-way road (Fig. 13.3).

The sign may be repeated on long stretches if considered necessary.

13.3.3. **One way:** The sign shall be located at the entry to the one-way street and repeated at intermediate intersections on that street.

13.3.4. **Vehicles prohibited in both directions:** The sign shall be used at the approach end of the roads where entry to all types of vehicular traffic is prohibited, especially in case of areas which have been designed as pedestrian malls.

13.3.5. **All motor vehicles prohibited:** The sign shall be used at the entrance to the roads where entry to all types of motor vehicles is prohibited (Fig. 13.7).

13.3.6. **Trucks prohibited:** The sign shall be erected on each entry to the road where movement of trucks is prohibited (Fig. 13.8).

13.3.7. **Bullock carts and hand carts prohibited:** The sign shall be erected on each entry to the road where all types of slow moving vehicles except cycles are to be prohibited (Fig. 13.9).

13.3.8. **Bullock carts prohibited:** The sign shall be erected on each entry to the road where bullock carts are to be prohibited (Fig. 13.10).

13.3.9. **Tongas prohibited:** The sign shall be erected on each entry to the road where tongas are to be prohibited (Fig. 13.11).

13.3.10. **Hand carts prohibited:** The sign shall be erected on each entry to the road where hand carts are to be prohibited (Fig. 13.12).

13.3.11. **Cycles prohibited:** The sign shall be erected on each entry to the road where cycles are to be prohibited (Fig. 13.13).

13.3.12. **Pedestrians prohibited:** The sign shall be erected on each entry to the road where pedestrians are to be prohibited (Fig. 13.14).

13.3.13. **Right/Left turn prohibited:** The sign shall be used at places, where vehicles are not allowed to make a turn to the right or left. The signs shall also be used at the inter-sections of one-way street to supplement the one-way sign (Figs. 13.15 and 13.16).

13.3. Prohibitory Signs (Figs. 13.3 to 13.19)

13.3.1. **Size, shape and colour:** The signs shall be of circular shape with a red border, white background, and black symbol. Their diameter shall be 90 cm in case of normal sized signs and 60 cm in the case of small sized signs. Width of the border shall be 75 mm and 50 mm.

A smaller size of 30 cm diameter may be used in conjunction with traffic light signals or on bollards on traffic islands. Widths of the border in that case shall be 35 mm.

13.3.2. **Straight prohibited/no entry:** The signs shall be located at places where the vehicles are not allowed to enter. It is generally erected at the end of one-way road to prohibit traffic entering the roadway in the wrong direction and also at each intersection along the one-way road (Fig. 13.3).

The sign may be repeated on long stretches if considered necessary.

13.3.3. **One way:** The sign shall be located at the entry to the one-way street and repeated at intermediate intersections on that street.

13.3.4. **Vehicles prohibited in both directions:** The sign shall be used at the approach end of the roads where entry to all types of vehicular traffic is prohibited, especially in case of areas which have been designed as pedestrian malls.

13.3.5. **All motor vehicles prohibited:** The sign shall be used at the entrance to the roads where entry to all types of motor vehicles is prohibited (Fig. 13.7).

13.3.6. **Trucks prohibited:** The sign shall be erected on each entry to the road where movement of trucks is prohibited (Fig. 13.8).

13.3.7. **Bullock carts and hand carts prohibited:** The sign shall be erected on each entry to the road where all types of slow moving vehicles except cycles are to be prohibited (Fig. 13.9).

13.3.8. **Bullock carts prohibited:** The sign shall be erected on each entry to the road where bullock carts are to be prohibited (Fig. 13.10).

13.3.9. **Tongas prohibited:** The sign shall be erected on each entry to the road where tongas are to be prohibited (Fig. 13.11).

13.3.10. **Hand carts prohibited:** The sign shall be erected on each entry to the road where hand carts are to be prohibited (Fig. 13.12).

13.3.11. **Cycles prohibited:** The sign shall be erected on each entry to the road where cycles are to be prohibited (Fig. 13.13).

13.3.12. **Pedestrians prohibited:** The sign shall be erected on each entry to the road where pedestrians are to be prohibited (Fig. 13.14).

13.3.13. **Right/Left turn prohibited:** The sign shall be used at places, where vehicles are not allowed to make a turn to the right or left. The signs shall also be used at the inter-sections of one-way street to supplement the one-way sign (Figs. 13.15 and 13.16).

13.4.4. **Location of 'No Stopping/Standing' sign:** The sign shall be erected on sections of a road or street where the controlling authority has decided to prohibit stopping of vehicles, even temporarily (Fig. 13.21).

13.4.3. **Location of 'No Parking' sign:** The sign shall be erected where the controlling authority has resolved to prohibit parking. The sign should be accompanied by suitable kerb or carriageway markings as indicated in IRC:35-1997 (Fig. 13.20)

In addition, the definition plate may exhibit a single-headed arrow pointing the direction in which the restriction is applicable if the sign is at the end of a zone, or a double-headed arrow pointing both ways if the sign is at an intermediate point in the zone.

- (i) the days of the week during which the prohibition applies,
- (ii) the hours of the day during which parking is prohibited,
- (iii) the distance upto which the prohibition is applicable, and
- (iv) exceptions granted for certain classes of road users.

13.4.2. **Combination with definition plate:** There shall be a definition plate below the signs carrying the words "No Stopping/Standing" as applicable in English and other language as necessary. The scope of the prohibition may be explained by inscriptions on the definition plate specifying as the case may be

A smaller size of 30 cm diameter may be used in conjunction with traffic light signals or on bollards on traffic islands. Width of the border and red oblique bar shall be 35 mm and 30 mm respectively.

of the border shall be 65 mm and 45 mm and that of the red oblique bar shall be 60 mm and 40 mm diameter shall be 60 cm in case of normal sized signs and 40 cm. in case of small sized signs. Width of the border shall be 65 mm and 45 mm and that of the red oblique bar shall be 60 mm and 40 mm respectively for normal and small sized signs.

13.4.1. **Size, shape and colour:** The signs shall be of circular shape with a red border and blue background. There will be an oblique red bar at 45 degrees for the, 'No Parking' sign and there will be two oblique red bars at 45 degrees and right angles to each other for, 'No Stopping' sign. Their diameter shall be 60 cm in case of normal sized signs and 40 cm. in case of small sized signs. Width of the border shall be 65 mm and 45 mm and that of the red oblique bar shall be 60 mm and 40 mm respectively for normal and small sized signs.

13.4. **No Parking and No Stopping/Standing Signs** (Figs. 13.20 and 13.21)

13.3.16. **Horn prohibited:** The sign shall be used on stretches of the road where sounding of horn is not allowed, such as, near hospitals and in silence zones (Fig. 13.19).

13.3.15. **Overtaking prohibited:** The sign shall be erected at the beginning of such sections of highways where sight distance is restricted and overtaking will be hazardous. The sign may be dispensed with where standard "No Lane Crossing" pavement markings (Ref. IRC:35-1997) exist (Fig. 13.18).

13.3.14. **U-turn prohibited:** The sign shall be used at the places where vehicles are forbidden to make a turn to reverse direction of travel between the sign and the next inter-section beyond it. The sign shall be erected at the start and at intervals along section of a road on which the controlling authority has authorised the prohibition. The spacing between any two successive signs should not exceed 120 metres on each side of the road (Fig. 13.17).

13.5. Speed Limit and Vehicle Control Signs (Figs. 13.22 to 13.27)

13.5.1. Size, shape and colour: The signs shall be of circular shape with a red border and bearing black symbols and numerals on white background. The diameter inclusive of the border shall be 60 cm in case of normal sized signs and 40 cm in case of small sized sign. The width of the border shall be 65 mm and 45 mm respectively.

A still smaller size of 30 cm diameter may be used in conjunction with traffic light signals or on bollards on traffic islands. Width of border shall be 35 mm in this case.

13.5.2. Location: These signs shall be erected at the beginning of any section of a road or the side of a structure, which is subject to prohibition or restriction so as to face the entering traffic. Additional signs shall be erected within the prohibited section at each intersection made by a road which is not subject to prohibition so as to face the entering traffic and inform it of the restriction. For speed limit, additional repeater signs may also be installed at suitable intervals where necessary.

13.5.3. Speed limit: The sign shall be located at the beginning of the section of the road or area covered by a speed restriction, with numerals indicating the speed limit in kilometre per hour. The speed limit should be marked in multiples of 5 kmph.

Where the speed limit is imposed only on a certain class or classes of motor vehicles, this shall be specified on a definition plate attached below the sign. Where in addition to a general speed limit applicable to other motor vehicles, a special speed limit is imposed on vehicles of a certain class or classes, the general speed limit shall be specified on the disc and special speed limit together with the class or classes of vehicles specified on the definition plate. Definition plate shall be rectangular in shape with red border.

The class or classes of motor vehicles on the definition plate should preferably be shown in symbols (Fig. 13.22).

13.5.4. Width limit: The sign shall be used where entry of vehicles exceeding a particular width is prohibited (Fig. 13.23).

13.5.5. Height limit: The sign shall be erected in advance of an overhead structure where entry is prohibited for vehicles whose height exceeds a certain limit (Fig. 13.24).

13.5.6. Length limit: The sign shall be erected where entry of vehicles exceeding a particular length is prohibited (Fig. 13.25).

13.5.7. Load limit: The sign shall be erected where entry is prohibited for vehicles whose laden weight exceeds a certain limit (Fig. 13.26).

13.5.8. Axle load limit: The sign shall be erected where entry is prohibited for vehicles whose axle load exceeds a particular limit. To indicate the presence of any weak bridge ahead a definition plan with 'Weak Bridge Ahead' may be posted (Fig. 13.27).

13.6. Restriction Ends Sign (Fig. 13.28)

13.6.1. Size, shape and colour: It shall be circular with a white background. The diameter of the circle shall be 60 cm in case of a normal sized sign and 40 cm in case of a small sized sign. There shall be a diagonal band of black colour at an angle of 45 degrees sloping downward from right to left. The width of the band shall be 130 mm in normal sized sign and 90 mm in small sized sign.

14.2. **Size, shape and colour:** The signs (shown in Figs. 14.1 to 14.43) shall be in the shape of an equilateral triangle, with apex pointing upwards. It shall have red border and black

14.1. The detailed dimensioned drawings of normal sized sign and symbols thereon are shown in *Plate-2* for ease of reproduction. For signs of other sizes, the symbols should be proportionately reduced or enlarged. The cautionary/warning signs are listed in *Annexure-2*.

14. CAUTIONARY/WARNING SIGNS

13.7.7. **Busway/buses only:** The sign shall mean that only buses are allowed and the other traffic is not allowed on this road/carrageway. The sign may be supported by supplementary plate with 'BUSES ONLY' written on it (Fig. 13.38).

13.7.6. **Pedestrians only:** The sign shall mean that only pedestrians are allowed and the traffic is not allowed on this road/carrageway. The sign may be supported by supplementary plate with 'PEDESTRIANS ONLY' written on it (Fig. 13.37).

13.7.5. **Compulsory sound horn:** The sign shall mean that the motor vehicles shall compulsorily sound horn at the location at which sign is placed, for instance at sharp curves on hill roads (Fig. 13.36).

13.7.4. **Compulsory cycle track/cycles only:** The sign shall notify cyclists that they must use the cycle track at the entrance to which it is placed, and shall notify the drivers of other vehicles that they are not entitled to use that track (Fig. 13.35).

13.7.3. **Compulsory keep left/right:** The sign is most frequently used on bollards or islands and refuges in the middle of the carrageway and at the beginning of central reserves of dual carrageway. It should not be used at breaks in an otherwise continuous central reserve. This sign is not to be used on the central island of a roundabout (Figs. 13.29 to 13.34).

13.7.2. **Compulsory direction signs-general warrant:** These signs shall, by arrow or arrows, indicate the appropriate direction(s) in which vehicles are obliged to proceed, or the only directions in which they are permitted to proceed.

13.7.1. **Size, shape and colour:** These signs shall be circular in shape with blue background and white border (2 mm), and having symbols in white. The diameter shall be 60 cm for normal sized sign and 40 cm for small sized sign. However, signs having a diameter of not less than 30 cm may be used in conjunction with traffic signals or on bollards on traffic islands.

13.7. **Compulsory Direction Control and other Signs** (Figs. 13.29 to 13.38)

13.6.2. **Purpose:** This sign shall indicate the point at which all prohibitions notified by prohibitory signs for moving vehicles ceases to apply.

symbols on white background. The side of the triangle shall be 90 cm for normal sized signs and 60 cm for small sized signs. The width of the border shall be 70 mm and 45 mm respectively.

14.3. Location: The warning signs should normally be located at the following distances in advance of the hazard warned against :

(a) Non-urban Locations

National Highways and State Highways	120 m	60 m
Major District Roads	90 m	50 m
Other District Roads	60 m	40 m
Village Roads	40 m	30 m

Plain or Rolling Terrain Hilly Terrain

These distances may be increased on steep downhill gradients to account for increased speed. Where map type advance direction signs are posted in advance of the inter-sections, the warning signs relating to these junctions could be avoided to eliminate the crowding of signs.

(b) Urban Locations

In urban locations, the warning signs should be located at about 50 metres away from the points of hazard. Distance may be increased or decreased to suit site conditions.

14.4. Curve Signs

14.4.1. These signs are to be used, wherever, the direction of alignment changes. These signs are intended to forewarn the driver to reduce the speed and proceed cautiously. The following Table gives the radii of curvature below which the signs are warranted:

National Highways and State Highways	360 m	90 m
Major District Roads	230 m	60 m
Other District Roads	155 m	33 m
Village Roads	90 m	23 m

Plain or Rolling Terrain Hilly Terrain

14.4.2. The right hand curve sign should be used to mark curves bearing to the right and the left hand curve sign for curves bearing to the left (Fig. 14.1).

14.5 Right/Left Hairpin Bend

The sign should be used to mark curves of small radii, where the change of direction is so considerable as to amount to a reversal of direction. The symbol should bend to left or right according to the road alignment (Fig. 14.3).

The sign should be erected to warn that the section of the road ahead may be particularly slippery. The sign should be removed immediately after the hazard is remedied (Fig. 14.9).

14.12. Slippery Road

The sign should be installed ahead of a gap in the median of a divided carriageway, other than at an intersection (Fig. 14.8).

14.11. Gap in Median

The sign should be erected on such sections of roads in rural areas where in the opinion of the controlling authority the sudden widening of a road causes a danger to traffic, such as, a two-lane road suddenly widening to a dual carriageway (Fig. 14.7).

14.10. Road Widens

The sign should be erected on such sections of roads in rural areas where in the opinion of the controlling authority a sudden reduction in width of pavement causes a danger to traffic (Fig. 14.6).

14.9. Narrow Road

The sign should be erected on roads in advance of bridges where the clear width between kerbs or wheel guards is less than the normal width of the carriageway (Fig. 14.5).

14.8. Narrow Bridge

14.7.2. **Steep descent:** The sign should be used 30 metres before a steep downgrade, where the erecting authority considers that the steepness of the grade may constitute a hazard to traffic. A gradient of 10 per cent and above may be considered as a steep gradient for this purpose. The sign should not be used unless the gradient continues for a length of about 1/2 km. It should be repeated at suitable intervals in the stretch having the steep descent (Fig. 14.4).

14.7.1. **Steep ascent:** The sign should be used 30 metres before a steep upgrade where the erecting authority considers that the steepness of the upgrade warrants a warning to the road users. A gradient of 10 per cent and above may be considered steep gradient for this purpose. The sign should not be used unless the gradient continues for a length of about 1/2 to 1 km. It should be repeated at suitable intervals in the stretch having the steep ascent (Fig. 14.4).

14.7. Steep Ascent/Descent

The sign should be erected where two curves in opposite direction are separated by a tangent less than 120 metres in length in plains and 30 metres in hills. The sign may also be erected where in the opinion of the controlling authority the nature of the reverse bend is not obvious to approaching drivers and constitutes a hazard. If the first curve is to the right, a right reverse bend sign shall be used. If the first curve is to the left, a left reverse bend sign shall be used (Fig. 14.3).

14.6. Right/Left Reverse Bend

14.13. Loose Gravel

The sign should be used on section of a road on which gravel may be thrown up by fast moving vehicles. The sign should be removed immediately after the hazard is remedied (Fig. 14.10).

14.14. Cycle Crossing

The sign should be erected in advance of all uncontrolled cycle crossings (Fig. 14.11).

14.15. Pedestrian Crossing

The sign should be erected in advance on both approaches to uncontrolled pedestrian crossings. This is absolutely essential when visibility of the crossing is impaired by a bend or hump in the road (Fig. 14.12).

14.16. School

The sign should be erected where school buildings or grounds are adjacent to the road, and where in the opinion of the controlling authority passing traffic creates a hazard to children (Fig. 14.13).

14.17. Cattle

The sign should be erected where there is danger due to farm animals or cattle crossing on the road. The sign should not be used simply because animals are driven along or across the road at frequent intervals but should be used where they cross regularly (Fig. 14.14).

14.18. Men at Work

The sign should be displayed only when men or machines are working on the road or adjacent to it or on overhead lines or poles. The sign should be removed immediately after the work is completed (Fig. 14.15).

14.19. Falling Rocks

The sign should be erected wherever rocks are liable to fall on the road either seasonally or throughout the year. The symbol may be reversed to show the side from which rockfall is expected. The highway authorities should cover the signs during the season when this problem does not exist (Fig. 14.16).

14.20. Ferry

The sign is intended to warn the drivers about the existence of a ferry crossing across a river. It is recommended that pair of signs be used for this purpose, one for advance warning located at 200 metres from the ferry, and the second erected near the ferry. The distance of the second sign from the ferry may be 50 to 100 metres in plain and rolling country and 30 to 60 metres in hills depending on the design speed (Fig. 14.17).

The sign should be erected in advance of the cross road where in the opinion of the controlling authority a sufficiently large volume of crossing or entering traffic together with restricted sight distance is likely to constitute a hazard. This sign should only be used when the drivers need to be warned of the existence of an intersection and no other indication, e.g., by a map type advance direction sign or traffic signal, is given (Fig. 14.18).

14.21. Cross Road

The sign should be erected in advance of the side road intersections where in the opinion of the controlling authority the nature of the inter-section is not obvious to approaching drivers. The width of bands should indicate the relative importance of the roads. This sign should only be used when the driver needs to be warned of the existence of a junction and no other indication, e.g., by a map type advance direction sign or traffic signal, is given (Fig. 14.19).

14.22. Side Road

14.23. T-Inter-section

The sign should be erected in advance of T-junctions where in the opinion of the controlling authority the nature of the inter-section is not obvious to approaching drivers. The width of bands should indicate the relative importance of the roads. This sign should only be used when the driver needs to be warned of the existence of a junction and no other indication, e.g., by a map type advance direction sign or traffic signal, is given (Fig. 14.20).

14.24. Y-Inter-section

The sign should be erected on the approach to a bifurcation of any road. This sign should only be used when the driver needs to be warned of the existence of a junction and no other indication, e.g., by a map type advance direction sign or traffic signal, is given (Fig. 14.21).

14.25. Staggered Inter-section

The sign should be used to indicate junctions where the distance between two junctions does not exceed 60 metres. This sign should only be used when the driver needs to be warned of the existence of a junction and no other indication, e.g., by a map type advance direction sign or traffic signal, is given (Fig. 14.22).

14.26. Major Road

The sign should be erected in advance of crossing with a major road, where in the opinion of the controlling authority a sufficiently large volume of traffic together with restricted sight distance is likely to constitute a hazard. The sign should not be used where the inter-section is controlled by traffic signal (Fig. 14.23).

14.27. Roundabout

The sign should be used where it is necessary to indicate the approach to a roundabout and adequate warning is not conveyed by a map type advance direction sign (Fig. 14.24).

14.28. Dangerous Dip

The sign should be erected where a sharp dip in the profile of the road or a causeway is likely to cause considerable discomfort to traffic (Fig. 14.25).

14.29. Rumble Strip

The sign should be posted 50-60 metres in advance of the rumble strips provided on the road to control the speed. This is to warn the drivers of the presence of the rumble strip (Fig. 14.26).

14.30. Barrier

The sign should be erected in advance of a gate controlling entry into a road. A pair of signs should be used for the purpose : (i) a warning sign with a definition plate bearing the words "SLOW, BARRIER AHEAD" installed at a distance of 200 metres from the barrier and (ii) another warning sign with a definition plate bearing the words "DEAD SLOW, BARRIER AHEAD" installed at a distance of 50-100 metres in plain and rolling terrain and 30-60 metres in hilly terrain. In case of toll barriers, the words "BARRIER AHEAD" may be replaced by "TOLL BARRIER AHEAD" (Fig. 14.27).

14.31. Unguarded Railway Crossing

The sign should be used on the approaches of level crossings where there are no gates or other barriers. A pair of signs shall be used for the purpose: (i) an advance warning sign located at 200 metres away from the crossing and (ii) a second sign to be erected near the crossing. The distance of the second sign from the crossing may be 50-100 metres in plain and rolling terrain and 30-60 metres in hilly terrain (Fig. 14.28).

14.32. Guarded Railway Crossing

The sign should be used to warn traffic on the approaches to guarded railway crossings. A pair of signs shall be used for the purpose : (i) an advance warning sign located at 200 metres away from the crossing and (ii) a second sign to be erected near the crossing. The distance of the second sign from the crossing may be 50-100 metres in plain and rolling terrain and 30-60 metres in hilly terrain (Fig. 14.29).

14.33. Speed Breaker: This sign should be used to warn the drivers of the presence of the speed breaker. This sign should be posted 50-60 metres in advance of the speed breaker location (Fig. 14.30).

14.34. Traffic Signals: This sign should be used to caution the drivers of the presence of traffic signals. This sign may be posted 50-100 metres in advance of the location of traffic signals (Fig. 14.31).

14.35. **Runway:** This sign is used to warn the drivers of the presence of runway ahead and possible movements of aircrafts. The sign may be posted at 50-100 metres in advance of the runway (Fig. 14.32).

14.36. **End of Dual Carriageway:** This sign is posted when dual carriageway is ending and single carriageway is starting. The sign may be posted at 100-150 metres from the end of dual carriageway (Fig. 14.33).

14.37. **Start of Dual Carriageway:** This sign is posted when a single carriageway ends up into a dual carriageway. The sign may be posted at 100 metres from the start of dual carriageway (Fig. 14.34).

14.38. **Series of Bends:** This sign should be used to caution the driver of the presence of zig-zag for a long distance over the section of road ahead. The sign may be posted 50-100 metres ahead of the section under question. The sign may be repeated at appropriate intervals if the zig-zag road is very long (Fig. 14.35).

14.39. **Traffic Diversion on Dual Carriageway:** This sign is used to warn the driver of the diversion of traffic from one carriageway to the other. Mostly it is used on dual carriageway when one carriageway is closed (Fig. 14.36).

14.40. **Overhead Cable:** This sign is used to caution the driver of the presence of overhead power transmission lines (Fig. 14.37).

14.41. **Quay Side or River Bank:** This sign is used to caution the driver of the presence of the water by the side of the road and the impending danger (Fig. 14.38).

14.42. **Two Way Operation:** This sign is used to caution the driver of a changed pattern of traffic operation on a carriageway expected to carry traffic in one direction only. For example, on a dual carriageway, the entire traffic is diverted to one side because of emergency or road work. In this situation drivers are warned by posting this sign (Fig. 14.39).

14.43. **Lane Closures:** This sign is used to caution the driver of the closure of a portion of the carriageway on multi-lane highways (Figs. 14.40 (a), 14.40 (b) and 14.40 (c)).

14.44. **Sudden Side Winds:** This sign is used to caution the driver of the danger of side winds, which endanger the lives of travellers. This sign is posted at places where such weather conditions exist. This will enable the driver to proceed cautiously and act appropriately in case of emergency (Fig. 14.41).

14.45. **Reduced Carriageway:** This sign is used to caution the driver of the reduction in the width of the carriageway ahead. This is applicable to undivided carriageway when some portion of the carriageway is closed or reduced for maintenance or repairs (Fig. 14.42).

14.46. **Rough Road:** This sign is posted in situations where the road is rough and the drivers are required to slow down their vehicles for safe travel (Fig. 14.43).

15. INFORMATORY SIGNS

15.1. The detailed dimensioned drawings of normal sized sign and symbols thereon are shown in Figs. 15.1 to 15.36, *Plate-3* for ease of reproduction. For signs of other sizes, the symbols should be proportionately reduced or enlarged. The informatory signs are listed in *Annexure-3*.

15.2. The signs are classified under the following sub-heads keeping in view their design and application:

- (1) Direction and Place Identification Signs
- (2) Facility Information Signs
- (3) Other Useful Information Signs
- (4) Parking Signs, and
- (5) Flood Gauge

15.3. Direction and Place Identification Signs

15.3.1. **Shape, colour and language of inscription:** These signs shall be rectangular. However, direction signs may be in the shape of an elongated rectangle with the longer side horizontal, terminating in an arrowhead. The signs shall have green background, white letters and arrows, and white border. Inscription shall be in English and other language(s) as necessary. Size of the letters shall as specified in para 10.3. To ensure uniformity and better legibility of advance directional signs guidelines are provided for designing them in *Annexure-4*. The guidelines include the letters and numerals and their placement with respect to borders and legends.

15.3.2. **Advance direction signs:** The sign indicates the routes ahead by showing the names of particular places with arrow symbols indicating directions. If desired, distance of places in kilometres may be shown after the destination names. If more than one place is to be shown in the same direction, the names of the places may be grouped and a single arrow used for direction indication. Names/Group of names of places be separated by a line as shown in Fig. 15.1. On high speed roads where the junctions are complex in layout large size signs (map type signs) shown in Fig. 15.2 may be employed. In situation where rotary (roundabout) inter-section exists, signs as shown in Fig. 15.3 may be employed. The sign shall normally be located at the same distance from the inter-section as given in para 14.3. Where the size of sign becomes very large to accommodate dual language it is advisable to install two separate signs with only one language on each. Such signs may be separated by 50 metres.

15.3.3. **Destination sign:** The sign should be posted in advance at inter-sections of major importance or at inter-sections where the approach speeds are high requiring advance information. The places with vertical arrow shall be at the top, the right arrow next, and the left arrow at the bottom of the assembly (Fig. 15.1).

15.3.4. **Directional sign:** The sign shows (Figs. 15.4 & 15.5) where a road leads to and indicates the names of towns, railway stations, aerodromes, or public centres, and the distance by road to them. Direction is indicated by the arrowhead at the end of the sign board, the board being placed generally parallel to the road leading to the place named.

15.3.5. **Reassurance sign:** The sign (Fig. 15.6) should be erected on important roads beyond an inter-section or a junction, to reassure a driver of a vehicle that the desired direction is being followed. Two place names along with their distances should normally be shown, the upper name being of the town or place with larger population or maximum importance on the route and the next name being of the place next in the order of importance.

15.3.6. **Place/city identification:** The sign (Fig. 15.7) should be used along highways to mark entrance to the place of city. It should be erected at the entrance to the area incorporated in the local authority. If the built-up area does not extend to the corporate line at the point where it crosses the highway, then the sign should be placed inside the incorporated area 90 metres in advance of the edge of the built-up section.

15.3.7. **Truck lay bye:** Along the National and State Highways the provision of Truck Lay Bys has become very necessary and as such the truck drivers must be adequately informed of the availability of such a facility. The sign of the type shown in Fig. 15.8 is to be provided with the directional arrow showing the direction in which the facility is located. These signs are posted in advance of the location where truck lay bye is provided.

15.3.8. **Toll booth ahead:** Where charges are levied and collected from the road users for their use of road facilities to collect these charges are set up, it is necessary to inform the road users of the presence of such facilities ahead of their arriving at them by posting a sign shown in Fig. 15.9. The sign is posted in advance of the toll booth between 500 to 1000 metres.

15.4. Facility Information Signs (Figs. 15.10 to 15.16)

15.4.1. **Size, shape and colour:** These signs shall be rectangular and have a blue background. White black symbol shall be displayed in white square to indicate the facility. The size of the normal sized sign shall be 80 cm x 60 cm and of the small sized sign 60 cm x 45 cm. Size of the symbol shall be as shown in figures. On the blue band at the bottom of the sign, the distance to the facility indicated or to the entry of the road leading to it, may be inscribed in white. The signs may also be set up at the entry to the road leading to the facility and may then bear a white directional arrow on the blue part at the bottom.

15.4.2. **Public telephone:** The sign should be erected on long stretches of roads in rural areas indicating the distance to the nearest public telephone on supplementary plate, especially where it is in an inconspicuous position (Fig. 15.10).

15.4.3. **Filling station (Petrol Pump):** The sign should be erected on long stretches of roads in rural areas at the entry to the road leading to the facility. It is not necessary when the facility is within sight and available at reasonably frequent intervals along the route (Fig. 15.11).

15.4.4. **Hospital:** The sign should be used to notify drivers of vehicles that they should take the precautions required near medical establishments and in particular that they should not make any unnecessary noise. The sign serves to indicate the location of hospital where medical facilities will be available (Fig. 15.12).

15.4.5. **First aid post:** The sign should be used to notify the drivers of vehicles on long stretches of roads in rural areas of the first aid facility which may be helpful in case of emergency (Fig. 15.13).

15.4.6. **Eating place:** The sign should be used to indicate where a regular eating place is located (Fig. 15.14).

15.4.7. **Light refreshment:** The sign should be used to indicate a place where light refreshments would be available (Fig. 15.15).

15.4.8. **Resting place:** The sign should be used to indicate where facilities for resting and lodging would be available. It shall be combined with a separate definition plate, indicating whether the place is a Rest House, Motel, Hotel, etc. (Fig. 15.16).

15.5. **Other Useful Information Signs** (Figs. 15.17 to 15.28)

The shape and colour of these signs shall be the same as those of 'Facility Information' signs. The symbols shall be according to the drawings shown.

15.5.1. **No through road:** The sign should be erected at the entrance to a road from which there is no exit (Fig. 15.17).

15.5.2. **No through side road:** The sign should be erected on the main road, with appropriate variations to the symbol so as to show the road layout, where it is considered essential to give advance indication of a 'No Through Side Road' (Fig. 15.18).

15.5.3. **Informatory sign for pedestrian subway:** To guide the pedestrian traffic to the Subway (Fig. 15.19).

15.5.4. **Airport:** The sign should be erected at the places where the Airport is situated nearby (Fig. 15.20).

15.5.5. **Repair facilities:** The sign should be erected at the places where the repair facilities are situated (Fig. 15.21).

15.5.6. **Police station:** The sign should be erected at the places where the Police Station is situated nearby (Fig. 15.22).

15.5.7. **Railway station:** The sign should be erected at the places where the Railway Station is situated nearby (Fig. 15.23).

15.5.8. **Contra flow bus lane:** This sign is installed to indicate the presence of bus lane to permit the operation of buses in the opposing direction of flow on one-way streets (Fig. 15.24(a)).

15.5.9. **Bus lane:** This sign is installed to inform the drivers of the presence of reserved bus lane in the carriageway. The operation of bus lane is supported by appropriate markings on the pavement to delineate the lane and indicate the bus only lane markings. These are generally mounted overhead with appropriate support (Fig. 15.24(b)).

15.5.10. **Bus stop:** The sign should be erected at the places where the buses are designated to stop (Fig. 15.25).

15.5.11. **Taxi stand:** The sign is to be erected where the taxis are expected to wait when not engaged/hired (Fig. 15.26).

15.5.12. **Auto-rickshaw stand:** The sign is to be erected where the auto-rickshaws are to wait (Fig. 15.27).

15.5.13. **Cycle-rickshaw stand:** The sign is to be erected where the cycle-rickshaws are to wait (Fig. 15.28).

15.6. **Parking Signs (Figs. 15.29 to 15.35)**

The parking sign, which may be set up parallel to the axis of the road, should indicate the places where parking of vehicles is authorised. The sign shall be square of 60 cm x 60 cm size. It shall bear the letter 'P' in white colour. The background colour shall be blue with white border. Symbols or inscriptions on an additional plate below the sign may show the direction in which the parking places lie or the categories of vehicles for which parking is reserved.

15.7. **Flood Gauge**

The sign should be installed at causeways and submersible bridges or culverts to indicate to the road users the height of the flood above the road level (Fig. 15.36).

LIST OF MANDATORY/REGULATORY SIGNS

1. Stop and Give Way Signs
 - (i) Stop
 - (ii) Give Way
2. Prohibitory Signs
 - (i) Straight Prohibited/No Entry
 - (ii) One Way
 - (iii) Vehicle Prohibited in Both Directions
 - (iv) All Motor Vehicles
 - (v) Truck Prohibited
 - (vi) Bullock Cart and Hand Cart Prohibited
 - (vii) Bullock Cart Prohibited
 - (viii) Tonga Prohibited
 - (ix) Hand Cart Prohibited
 - (x) Cycle Prohibited
 - (xi) Pedestrian Prohibited
 - (xii) Right/Left Turn Prohibited
 - (xiii) U-turn Prohibited
 - (xiv) Overtaking Prohibited
 - (xv) Horn Prohibited
3. No Parking and No Stopping Signs
 - (i) No Parking
 - (ii) No Stopping/Standing
4. Speed Limit and Vehicle Control Signs
 - (i) Speed Limit
 - (ii) Width Limit
 - (iii) Height Limit
 - (iv) Length Limit
 - (v) Load Limit
 - (vi) Axle Load Limit
5. Restriction Ends Signs
6. Compulsory Direction Control and Other Signs
 - (i) Compulsory Turn Left/Right
 - (ii) Compulsory Ahead Only
 - (iii) Compulsory Turn Right/Left Ahead
 - (iv) Compulsory Ahead or Turn Right
 - (v) Compulsory Ahead or Turn Left
 - (vi) Compulsory Keep Left
 - (vii) Compulsory Cycle Track
 - (viii) Compulsory Sound Horn
 - (ix) Pedestrians Only
 - (x) Buses Only

LIST OF CAUTIONARY/WARNING SIGNS

1.	Right Hand/Left Hand Curve	1.
2.	Right/Left Hairpin Bend	2.
3.	Right/Left Reverse Bend	3.
4.	Steep Ascent/Descent	4.
5.	Narrow Bridge	5.
6.	Narrow Road Ahead	6.
7.	Road Widens Ahead	7.
8.	Gap in Median	8.
9.	Slippery Road	9.
10.	Loose Gravel	10.
11.	Cycle Crossing	11.
12.	Pedestrian Crossing	12.
13.	School	13.
14.	Cattle	14.
15.	Men at Work	15.
16.	Falling Rocks	16.
17.	Ferry	17.
18.	Cross Roads	18.
19.	Side Road	19.
20.	T-Intersection	20.
21.	Y-Intersection	21.
22.	Staggered Intersection	22.
23.	Major Road Ahead	23.
24.	Roundabout	24.
25.	Dangerous Dip	25.
26.	Rumble Strip	26.
27.	Barrier Ahead	27.
28.	Unguarded Railway Crossing	28.
29.	Guarded Railway Crossing	29.
30.	Speed Breaker Ahead	30.
31.	Traffic Signal Ahead	31.
32.	Runway Ahead	32.
33.	End of Dual Carriageway	33.
34.	Start of Dual Carriageway	34.
35.	Series of Bends	35.
36.	Overhead Cables Ahead	36.
37.	Quayside or River Bank	37.
38.	Two Way Operation Ahead	38.
39.	Lane Closure Ahead	39.
40.	Traffic Diversion on Dual Carriageway	40.
41.	Sudden Side Winds Ahead	41.
42.	Reduced Carriageway	42.
43.	Rough Road	43.

LIST OF INFORMATORY SIGNS

Annexure-3

1. Direction and Place Identification Signs
 - (i) Advance Direction
 - (ii) Destination
 - (iii) Direction
 - (iv) Reassurance
 - (v) Place Identification
 - (vi) Truck Lay Bye
 - (vii) Toll Booth Ahead
2. Facility Information Signs
 - (i) Public Telephone
 - (ii) Filling Station (Petrol Pump)
 - (iii) Hospital
 - (iv) First Aid Post
 - (v) Eating Place
 - (vi) Light Refreshment
 - (vii) Resting Place
3. Other Useful Information Signs
 - (i) No Through Road
 - (ii) No Through Side Road
 - (iii) Informatory Sign for Pedestrian Subway
 - (iv) Repair Facilities
 - (v) Airport
 - (vi) Police Station
 - (vii) Railway Station
 - (viii) Bus Lane Signs
 - (ix) Bus Stop
 - (x) Taxi Stand
 - (xi) Auto Rickshaw Stand
 - (xii) Cycle Rickshaw Stand
4. Parking Signs
5. Flood Gauge

RULES FOR THE DESIGN OF INFORMATORY ROAD SIGNS

Alphabets

(i) The Transport Medium alphabets are recommended for use of white letters on a dark background (blue, green or red). Alphabets comprises capital and lower-case letters, numerals and associated characters, and each of these is placed on a tile to assist in spacing. These alphabets and associated characters are shown in Figs. 4 (a) to 4 (c). Tile widths and associated spacings are indicated in Table 4 (a).

(ii) Letter size shall be expressed as centimeters of 'x' height, which is the height of a lower case letter 'x' within the alphabet concerned. The height of the alphabet from which they are taken, for example, 'capitals from the 10 cm 'x' height alphabet'. Where, however, capitals alone are used on a sign they may be described in terms of their actual height.

(iii) Stroke-width, referred to as S/W, is the thickness of the capital letters I in the Transport Medium alphabet whatever size of alphabet is being used on the sign. This stroke-width is never based on the Transport Heavy alphabet.

Layout of Signs

A. General

(i) All dimensions are expressed in terms of stroke-widths (S/W).

(ii) Spaces are measured between the tile edges of letters (and never between the letters themselves), but direct to symbols, borders and arrows.

(iii) All place names on a sign shall be in letters of the same size, regardless of the relative importance of the place. A smaller letter size may only be used for a name which is too long to fit into a reasonable sized sign and which cannot be hyphenated or abbreviated.

(iv) Route letters and numbers shall be from the same size alphabet as is used for the related place name.

B.

Letter and word spacing

(i) Words are formed by butting tiles closely together.

(ii) Tiles of words stacked one above the other shall be butted closely together [(but see also C (iv)(g)].

(iii) Related words on the same line, as in the phrase, shall be separated by 1/2 S/W.

(iv) Route letters and route numbers shall be separated by 1 1/2 S/W.

(v) Route letters shall be 2 S/W away place names when on the same line.

(vi) There shall be 3 S/W space between a route number and a bracketed route number on the same line.

Table 4 (a). Tile Widths for Transport Medium Alphabets*

Upper Case	Tile Width	Lower Case	Tile Width	Numerals and Punctuation Marks	Tile Width	Remarks
A	136	a	111 (104)	1	79	1. Tile widths are percentage of X height.
B	147	b	117	2	120	2. Figures in brackets apply in the following situations:
C	148	c	103	3	127	a) when T, V, Y is followed by a, e, d, u, g, r, s, w, y special tiles of lesser widths are used for both the Upper and Lower case letters.
D	154	d	119	4	132	b) When Upper case W is followed by another upper case letter a special increased tile width is used.
E	132	e	109	5	122	3. Tile height is two times X-height.
F	119	f	75	6	126	4. 'X' height for a place name is 100 mm. For multi-lane highways with divided carriageway. This may be increased to 150 mm.
G	155	g	114	7	104	5. 'X' height for direction signs is 150 mm. For multi-lane width divided carriageway this may be increased to 200 mm. For over head signs this may be increased to 300 mm.
H	160	h	112	8	130	6. Signs sizes are to be determined from tile widths plus allowances for border.
I	73	i	54	9	128	7. Upper case letters height is 1.4 X height.
J	93	j	58	0	133	8. Stroke width is 25 mm for directional signs.
K	138	k	108	1/4	123	9. Stroke width is 20 mm for place names.
L	107	l	62	1/2	132	10. The stroke width could be varied from 1/5 to 1/6 of the X-height as a general practice.
M	184	m	164	3/4	148	
N	168	n	112	-	66	
O	156	o	118		53	
P	130	p	118		53	
Q	158	q	118	(105	
R	141	r	73)	105	
S	137	s	97		39	
T	109	t	81		53	
U	154	u	115			
V	130	v	98			
W	183	w	147			
X	128	x	104			
Y	123	y	98			
Z	119	z	97			

* Complying with Geneva Convention on Road Signs and Signals

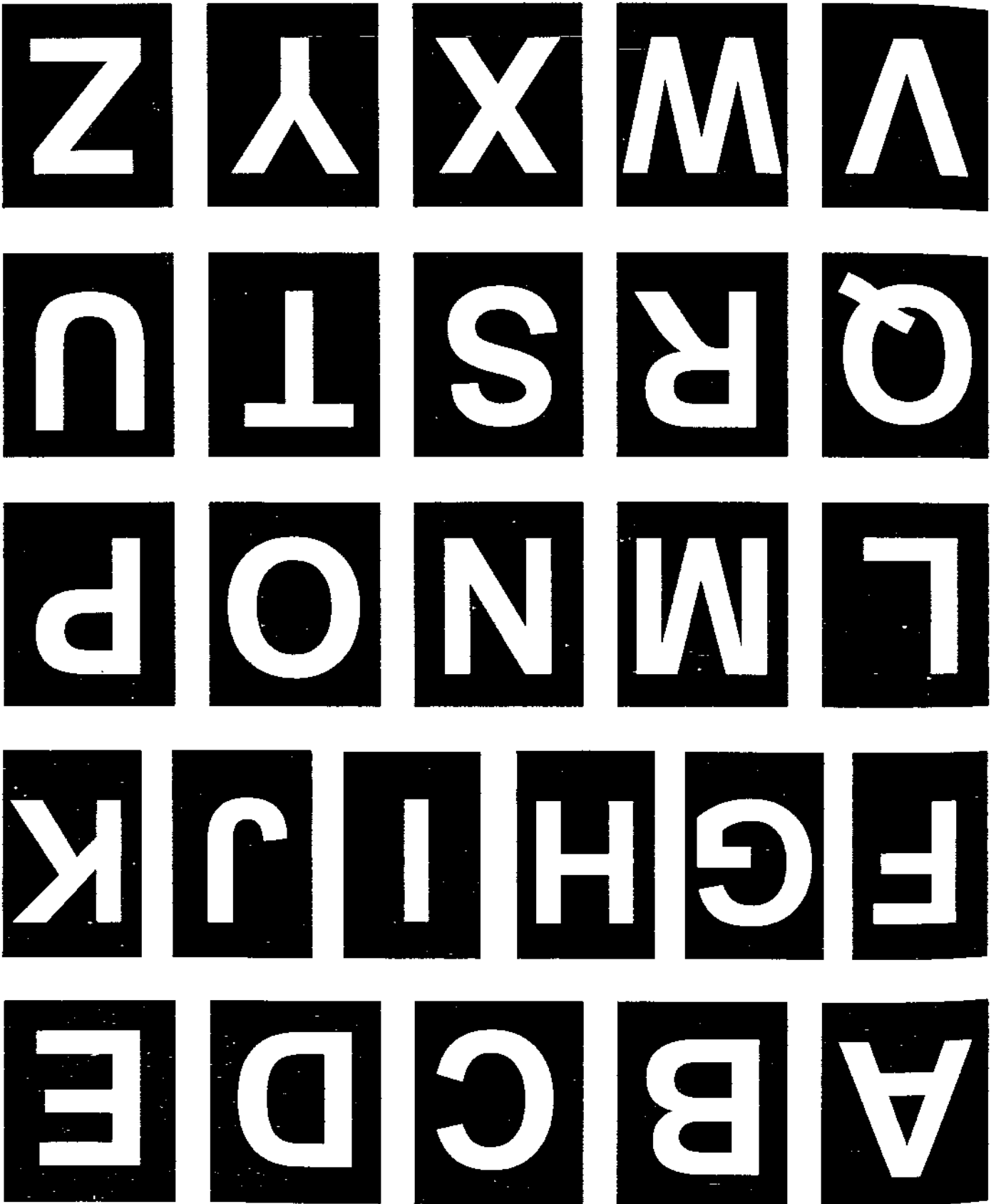

Fig. 4 (a). Transport medium capital alphabet for use on signs with dark backgrounds

Fig. 4 (b). Transport medium lower-case alphabet for use on signs with dark backgrounds

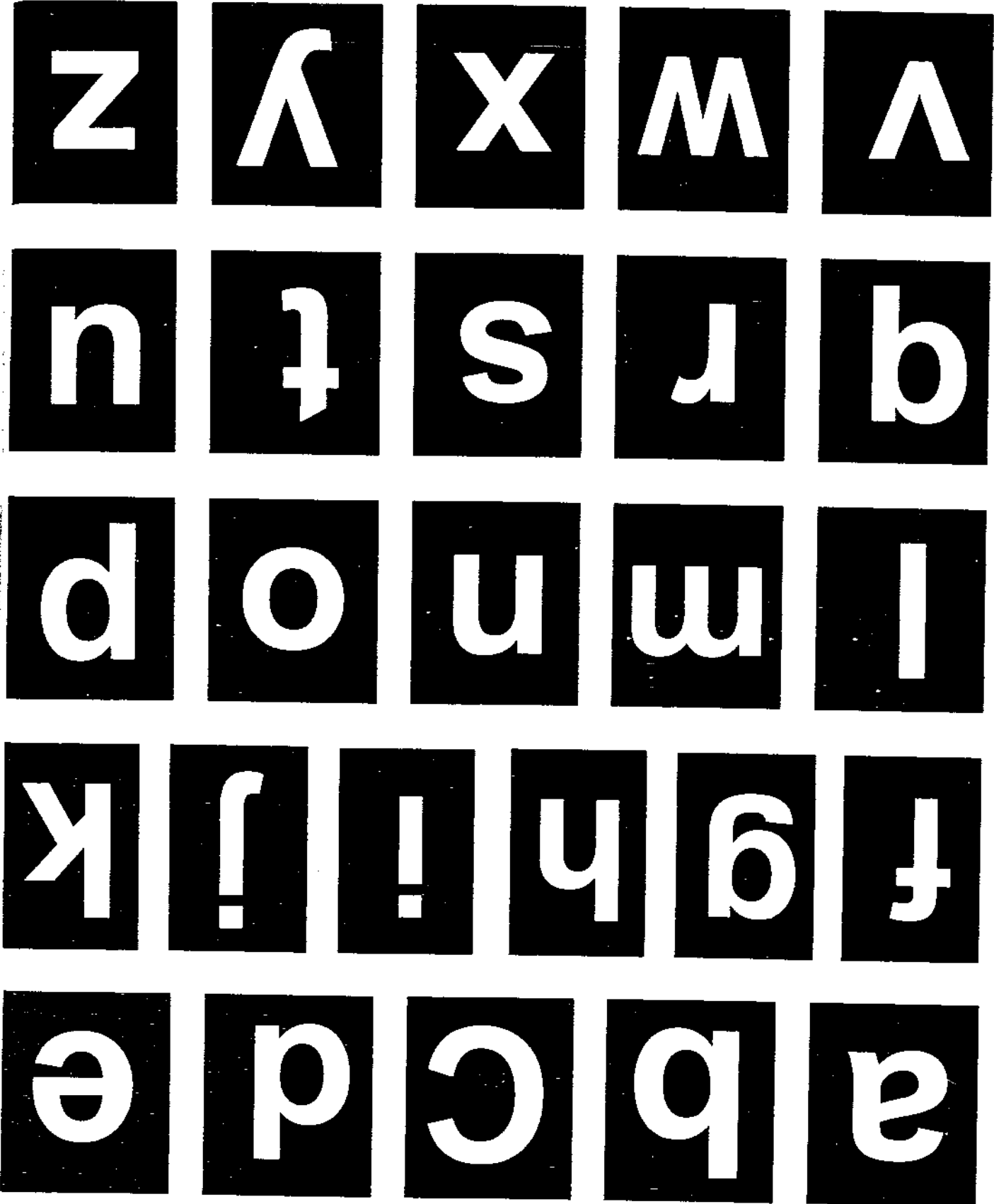
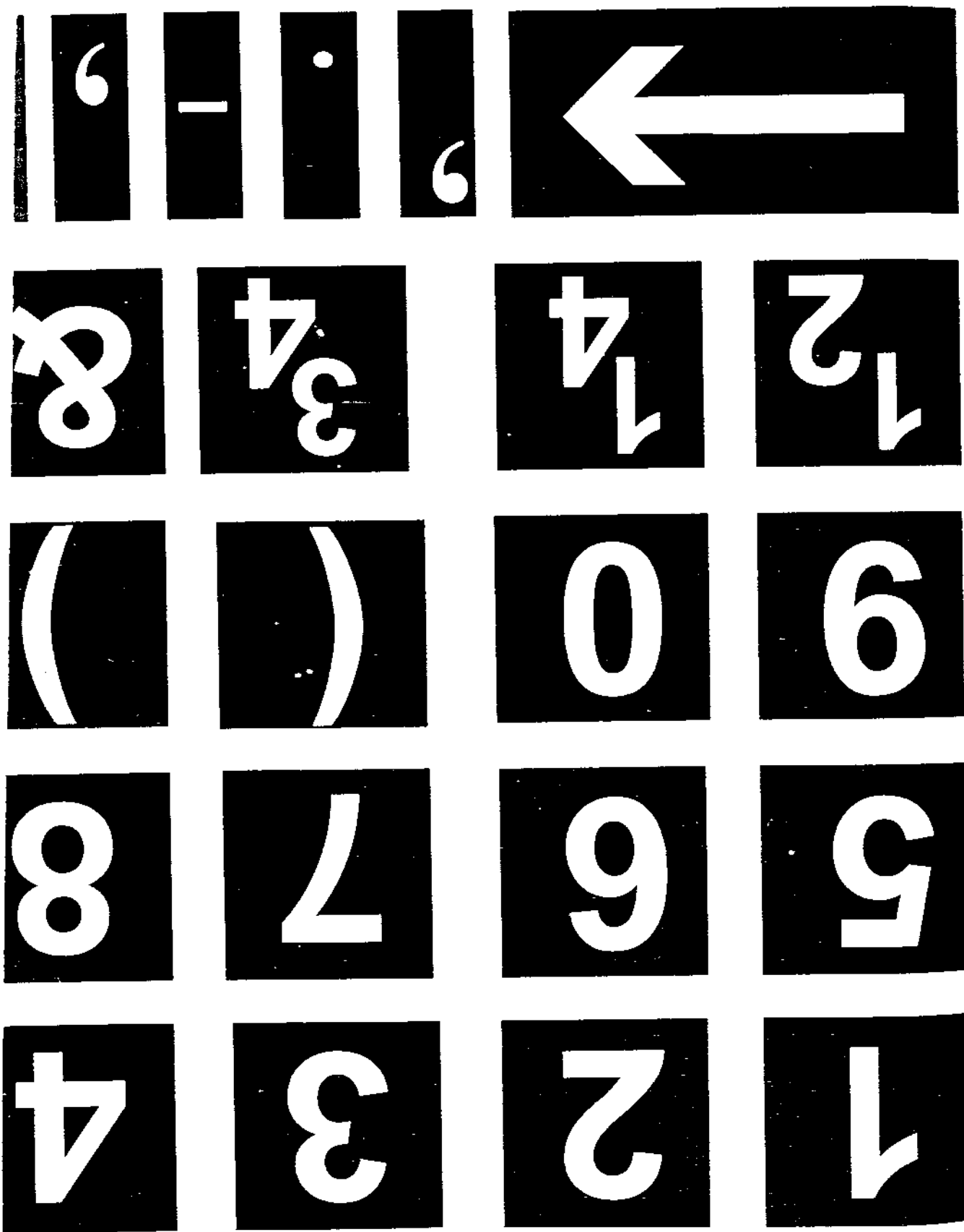

Fig. 4 (c). Transport medium numerals and other characters for use on signs with dark backg.



(vii) When a two-word place name has to occupy two lines the words shall be centred on one another.

C. Map type advance direction signs (other than for roundabouts)

- (i) Borders
 - (a) These shall be 1 1/2 S/W wide
 - (b) They shall be radially 2 S/W on internal corners.
- (ii) Route symbols
 - (a) The width of the route symbol shall be 6 S/W when indicating a National or State Highway 2 1/2 S/W for Village Roads and 4 S/W for all District Roads.
 - (b) The tips of route symbols shall be chamfered 90°.
 - (c) Internal angles at the junction of route symbols shall be radially 1 S/W.
 - (d) Side turning route symbols shall extend to two-thirds of the distance from the forward symbol to the border.

(iii) Relation of elements

- (a) Route numbers should follow place names on the same line. If space does not permit this they shall be placed below and aligned with the initial of the place name or if this is impracticable be aligned with the last letter of the place name.
- (b) When there is more than one destination related to a route symbol all place names should be stacked, with their initial letter aligned.
- (c) Forward destination(s) shall be centred over forward route symbols.
- (d) Exceptionally, on a sign with only one side turning the forward destination should be above the route symbol but may be displaced from centre to range right or left with the outside extremity of the right or left turning destination.
- (e) Back and side destinations shall normally be below route symbols but very exceptionally may be placed above route symbols when the forward destination is 18 S/W distant.
- (f) Route numbers and place names shall be a minimum of 4 S/W from an unrelated oblique route symbol.

(iv) Spacing of elements

- (a) There shall be 2 1/2 S/W between the top border and the forward destination.
- (b) There shall be 2 1/2 S/W between side borders and place names or route numbers.
- (c) There shall be 1 1/2 S/W between the bottom border and the nearest place name or route number but 1 S/W when there are no descenders in the bottom line.
- (d) There shall be a minimum of 4 S/W between the vertical route symbol and the nearest place name or route number laterally.

- (ix) Arrows shall be of a size appropriate to the alphabet.
- (viii) Groups of place names/route numbers within panels shall be separated vertically by 1 S/W place name.
- (vii) Route numbers shall be placed below place names and aligned with the initial of the place name.
- (vi) Figured mileages shall follow place names on the same line and shall be at a distance of 3 S/W from them.
- (v) Within panels, the border shall be separated from the top and sides by 2½ S/W and from the base by 1½ S/W.
- (iv) Internal corners of panels shall be radiused 1 S/W. External corners of sign plates shall be radiused 2 S/W.
- (iii) Black borders on local advance direction signs shall be 4 S/W.
- (ii) Between panels divisions of letter colour shall be 1 S/W.
- (i) Where a border is of the same colour as the letters it shall be 1½ S/W.

E. Stack type signs

- (ii) When it is more economical on roundabout signs especially where there is a group comprising more than one destination and route number, destinations may be placed to one side of an oblique route symbol, but see especially C (iv) (g).
- (iii) The minimum distance between the route entering a roundabout and destinations to left and right shall be 6 S/W on the left and 5 S/W on the right.
- (iv) There shall be a minimum of 2 S/W between a destination and the nearest point on the perimeter of a roundabout symbol.

Number of roads	Internal radius	External radius	Length of entry arm	Minimum length of route symbol from centre of roundabout
1 entry + 3 exits	7	12	22	24
1 entry + 4 exits	8	13	30	30

(i) Dimension of roundabout symbols

D. Map type advance direction signs for roundabouts

- (e) There shall be 1½ S/W between route symbols and the place names below.
- (f) Forward route symbols shall built up directly to forward destinations, but where there is a descender immediately over the symbol point a stroke thickness should be inserted.
- (g) There shall be a minimum of 12 S/W vertically and 10 S/W horizontally between blocks of names/route numbers.
- (h) The bottom of the forward route symbol shall be 1½ S/W from the bottom border.

- F. Direction signs**
- (x) Arrows shall be on the left of forward and left-turn destinations and to the right of right-turn destination. Arrows for other than right-angle turns shall be set at 45°.
 - (xi) Arrows shall be centred vertically on related destinations, however, numerous these may be.
 - (xii) Forward pointing and oblique arrows shall be 3 S/W from side borders.
 - (xiii) Vertically pointing arrows shall be 1½ S/W from borders.
 - (xiv) Vertically pointing arrows if related to a single place name shall be reduced to 1 S/W in length.
 - (xv) Destinations or route numbers shall be 2½ S/W from arrows.

- G. Route confirmatory signs**
- (i) The appropriate end of the sign plate shall be chamfered 120°, the pointed end being radiused 1 S/W.
 - (ii) A chevron of the letter colour shall be placed vertically at a distance of 3½ S/W from the end border and 1½ S/W from the top and bottom borders.
 - (iii) 1½ S/W shall separate the chevron from the nearest destination in any direction.
 - (iv) Where used on signs with 1 line of information chevrons shall be 3½ S/W wide, with 2 lines of information 4 S/W wide, 3 lines 4½ S/W wide and 4 lines 5 S/W wide.

- H. Supplementary plates and informative signs (other than directional signs)**
- (i) Route numbers shall be centred over place names and mileages.
 - (ii) Place names shall be ranged left.
 - (iii) Mileages shall follow related place names on the same line and shall be ranged right.

- (i) The lines of legend shall be centred one over the other.
- (ii) The borders of the plates shall be 1 S/W.
- (iii) Internal corners shall be radiused 1 S/W.
- (iv) Any panels shall be separated by a horizontal line ¼ S/W wide.
- (v) Supplementary plates should be placed below the sign to which they relate at a distance of an 'x' height of the lettering on the plate.

Note: The dimensions in cm are those used to design the sign and position the legend in terms of spacing of elements, borders, route symbols, etc.

S/Ws	'X' - height (in cm)					
	5	7.5	10	15	20	25
1	1.2	1.8	2.4	3.6	4.84	6.0
1.5	1.8	2.7	3.6	5.4	7.2	9.0
2	2.4	3.6	4.8	7.2	9.6	12.0
2.5	3.0	4.5	6.0	7.5	10.0	12.5
3	3.6	5.4	7.2	10.8	14.4	18.0
4	4.8	7.2	9.6	14.4	19.2	24.0
5	6.0	9.0	12.0	18.0	24.0	30.0
6	7.2	10.8	14.4	21.6	28.8	36.0
7	8.4	12.6	16.8	25.2	33.6	42.0
8	9.6	14.4	19.2	28.8	38.4	48.0
9	10.8	16.2	21.6	32.4	43.2	54.0
10	12.0	18.0	24.0	36.0	48.0	60.0
12	14.4	21.6	28.8	43.2	57.6	72.0
13	15.6	23.4	31.2	46.8	62.4	78.0
20	24.0	36.0	48.0	72.0	96.0	120.0
30	36.0	54.0	72.0	108.0	144.0	180.0

Table of measurements of stroke widths in centimetres

1. Table of measurements of stroke widths
The following Table shows the measurement in centimetres of the more commonly used multiples of stroke widths.

1. THE HEIGHT OF OCTAGON FOR 'STOP SIGN' IS 90 CM FOR NORMAL SIZED SIGN AND 60 CM FOR SMALL SIZED SIGN. THE WIDTH OF WHITE BORDER SHALL BE 30 MM AND 20 MM RESPECTIVELY.
2. EACH SIDE OF EQUILATERAL TRIANGLE IS 90 CM FOR NORMAL SIZED SIGN AND 60 CM FOR SMALL SIZED SIGN. THE WIDTH OF RED BORDER SHALL BE 70 MM AND 45 MM RESPECTIVELY.
3. THE DIAMETER OF THE CIRCLE IS 90 CM FOR NORMAL SIZED SIGN AND 60 CM FOR SMALL SIZED SIGN. THE WIDTH OF RED BORDER SHALL BE 65 MM AND 45 MM RESPECTIVELY. THE WIDTH OF RED OBLIQUE BAR SHALL BE 60 MM AND 40 MM RESPECTIVELY.
4. THE SIZE OF THE SYMBOLS SHOWN IN THE DRAWINGS IS FOR NORMAL SIZED SIGN. FOR SIGNS OF OTHER SIZES, THE SYMBOLS SHOULD BE PROPORTIONATELY REDUCED.
5. THE WIDTH OF BLACK OBLIQUE BAR IN THE CASE OF RESTRICTION ENDS SIGN IS 130 MM FOR NORMAL SIZED AND 90 MM FOR SMALL SIZED SIGN.

MANDATORY/REGULATORY SIGNS

PLATE-1

STOP AND GIVE WAY SIGNS

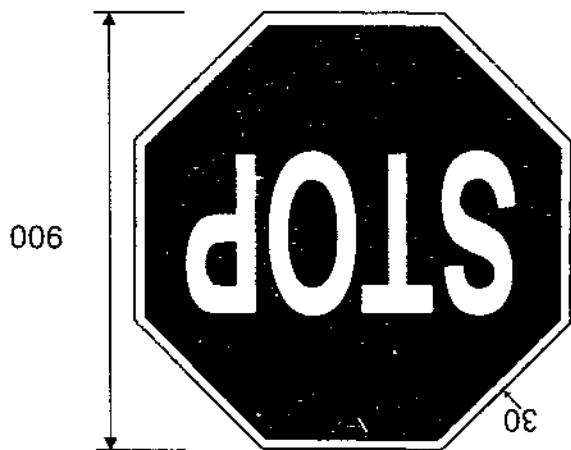

STOP SIGN
Fig. 13.1

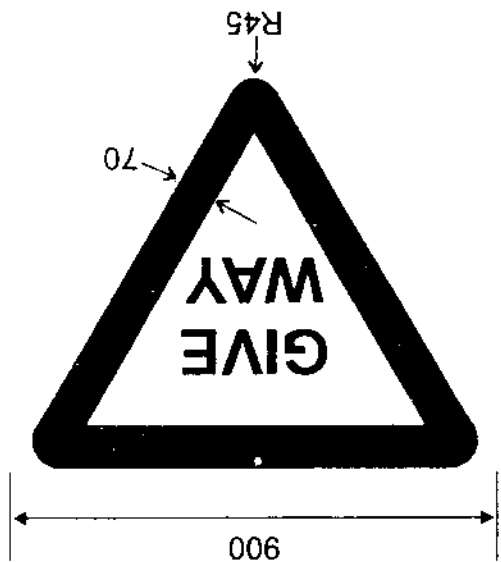

GIVE WAY SIGN
Fig. 13.2

1. Dimensions shown are for normal sized signs
2. All dimensions are in millimetres

PROHIBITORY SIGNS

Fig. 13.3
STRAIGHT PROHIBITED
OR NO ENTRY

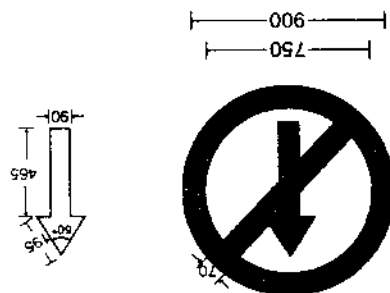

Fig. 13.4
NO ENTRY

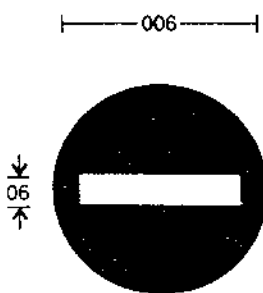

Fig. 13.5
ONE WAY SIGNS

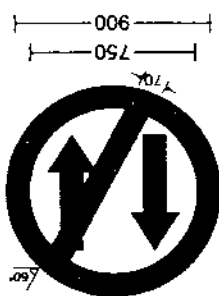
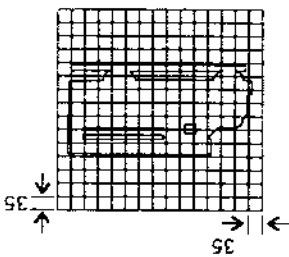

Fig. 13.6
VEHICLES PROHIBITED
IN BOTH DIRECTIONS



1. Dimensions shown are for normal sized signs
2. All dimensions are in millimetres



750
900

TRUCK PROHIBITED
Fig. 13.8

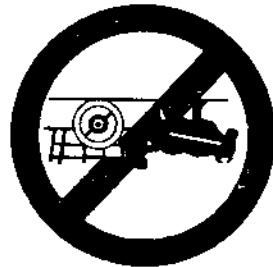
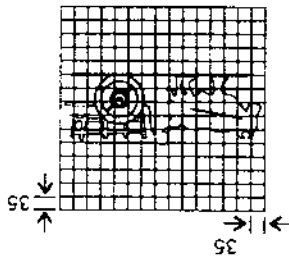

750
900

BULLOCK CART PROHIBITED
Fig. 13.10

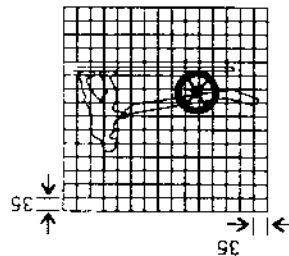

750
900

HAND CART PROHIBITED
Fig. 13.12

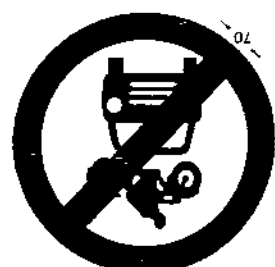
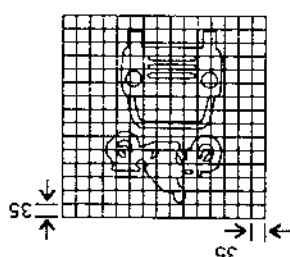

750
900

ALL MOTOR VEHICLES
PROHIBITED
Fig. 13.7

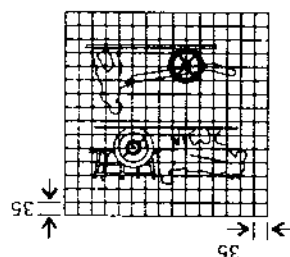

750
900

BULLOCK CART & HAND
CART PROHIBITED
Fig. 13.9

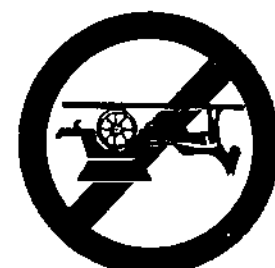
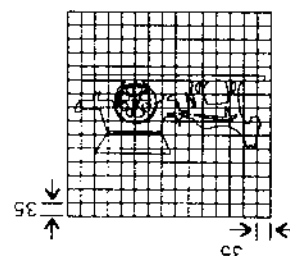

750
900

TONGA PROHIBITED
Fig. 13.11

1. Dimensions shown are for normal sized signs
2. All dimensions are in millimetres

1. Dimensions shown are for normal sized signs
 2. All dimensions are in millimetres

Fig. 13.17
 U-TURN PROHIBITED

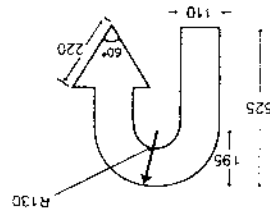
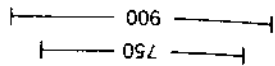

Fig. 13.18
 OVERTAKING PROHIBITED

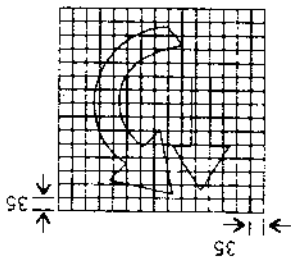
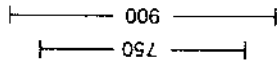

Fig. 13.15
 RIGHT TURN PROHIBITED

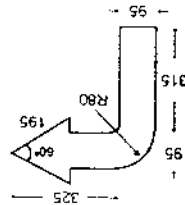
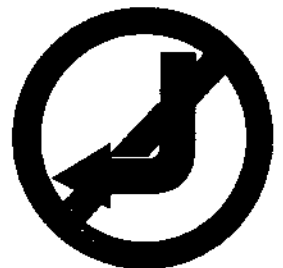
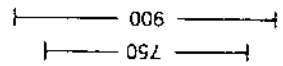

Fig. 13.16
 LEFT TURN PROHIBITED

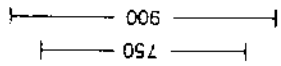

Fig. 13.14
 PEDESTRIAN PROHIBITED

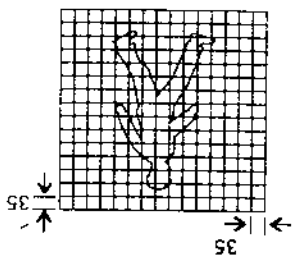
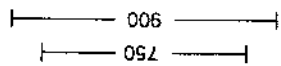
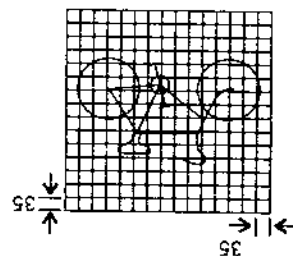
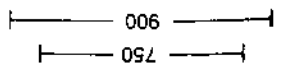
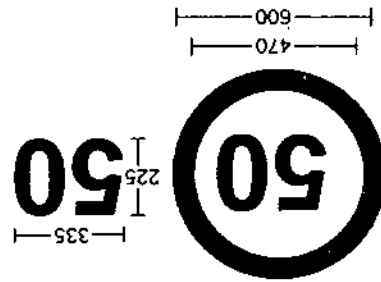

Fig. 13.13
 CYCLE PROHIBITED



1. Dimensions shown are for normal sized signs.
2. All dimensions are in millimetres.
3. A definition plate may be attached with the No Parking and No Stopping signs carrying the message in English and other languages as necessary, as also any additional information such as the period during which the restrictions will be in force or the particular vehicles to which it applies.
4. Speed limits for different classes of vehicles may be indicated in separate definition plate attached to the Speed Limit sign.

Fig. 13.22
SPEED LIMIT



SPEED LIMIT AND VEHICLE CONTROL SIGNS

Fig. 13.20
NO PARKING

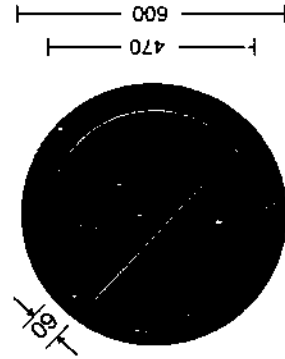
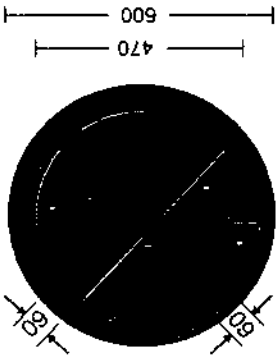
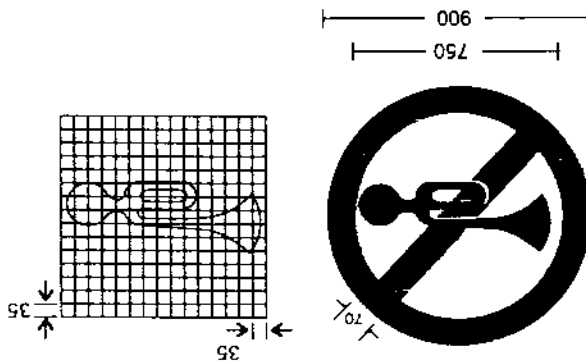

Fig. 13.21
NO STOPPING OR STANDING



NO PARKING AND NO STOPPING SIGNS

Fig. 13.19
HORN PROHIBITED



1. Dimensions shown are for normal sized signs
2. All dimensions are in millimetres

Fig. 13.28

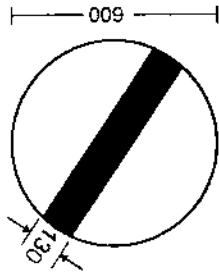

RESTRICTION ENDS SIGNS

Fig. 13.25
LENGTH LIMIT

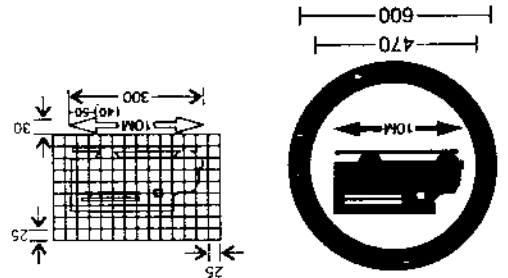

Fig. 13.26
LOAD LIMIT

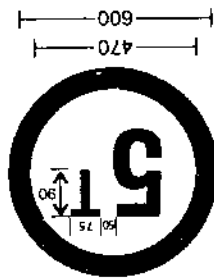

Fig. 13.27
AXLE LOAD LIMIT

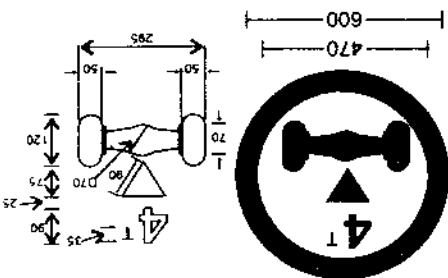

Fig. 13.23
WIDTH LIMIT

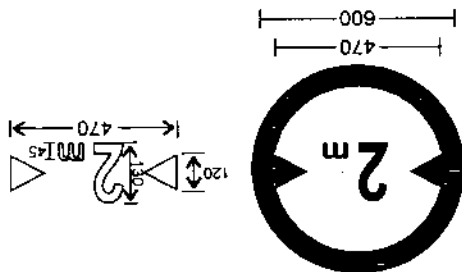
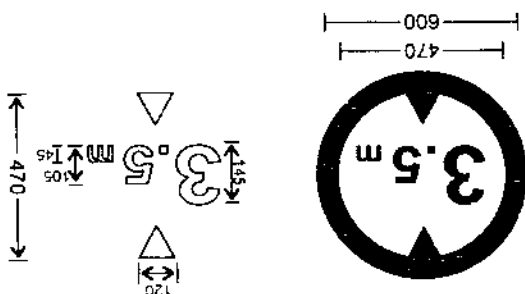
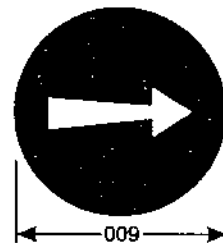

Fig. 13.24
HEIGHT LIMIT



**COMPULSORY DIRECTION CONTROL
AND OTHER SIGNS**



**COMPULSORY
TURN LEFT
(FOR TURN RIGHT, SYMBOL TO
BE REVERSED)**

Fig. 13.29

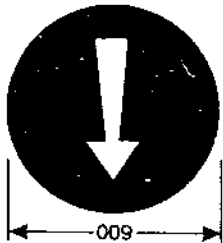

**COMPULSORY
AHEAD ONLY**

Fig. 13.30

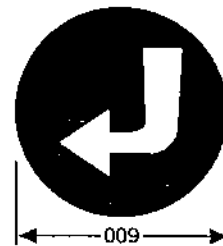
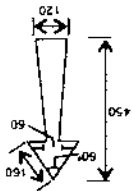

**COMPULSORY
TURN RIGHT AHEAD
(FOR TURN LEFT, SYMBOL TO
BE REVERSED)**

Fig. 13.31

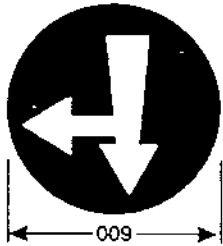
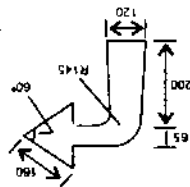

**COMPULSORY
AHEAD OR TURN RIGHT**

Fig. 13.32

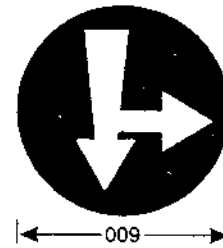

**COMPULSORY
AHEAD OR TURN LEFT**

Fig. 13.33

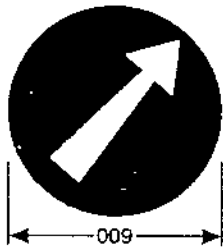
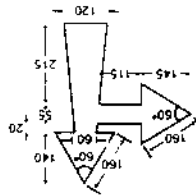

**COMPULSORY
KEEP LEFT**

Fig. 13.34

1. Dimensions shown are for normal sized signs
2. All dimensions are in millimetres

1. Dimensions shown are for normal sized signs
2. All dimensions are in millimetres

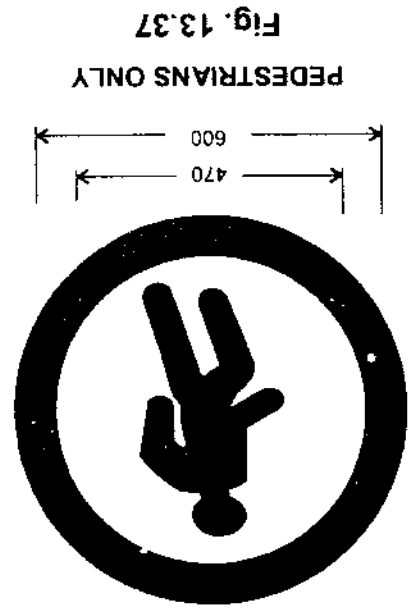
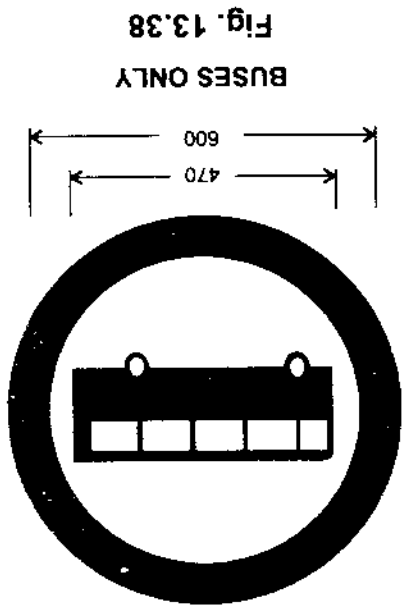

COMPULSORY SOUND HORN
Fig. 13.36

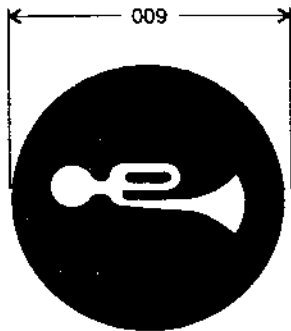

COMPULSORY CYCLE TRACK
Fig. 13.35

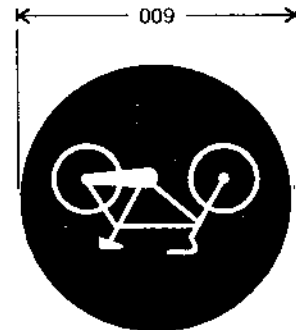

THE SIZE OF THE TRIANGLE SHALL BE 90 CM FOR NORMAL SIZED SIGN AND 60 CM FOR SMALL SIZED SIGN. THE WIDTH OF THE BORDER SHALL BE 70 MM AND 45 MM RESPECTIVELY. THE SIZE OF THE SYMBOLS SHOWN IN DRAWINGS IS FOR NORMAL SIZED SIGN AND IN THE CASE OF SMALL SIZED SIGN, THE SYMBOL SHOULD BE TWO-THIRDS OF THE SIZE SHOWN IN THE DRAWINGS.

CAUTIONARY/WARNING SIGNS

PLATE-2

1. Dimensions shown are for normal sized signs
2. All dimensions are in millimetres

REVERSE BEND
Fig. 14.3

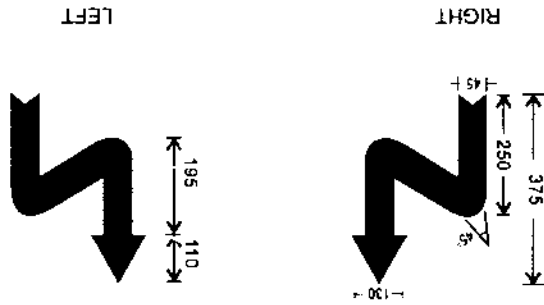

HAIR PIN BEND
Fig. 14.2



CURVE
Fig. 14.1

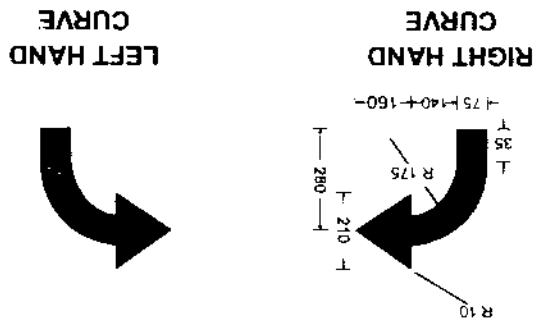

TYPICAL CAUTIONARY SIGN

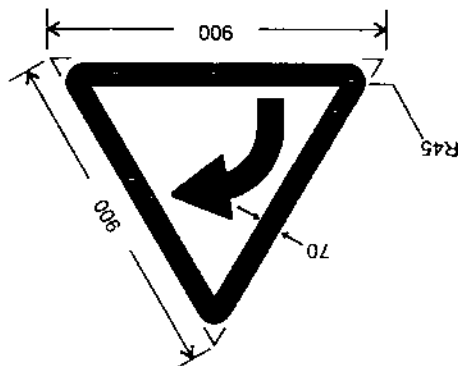

1. Dimensions shown are for normal sized signs
 2. All dimensions are in millimetres

Fig. 14.8

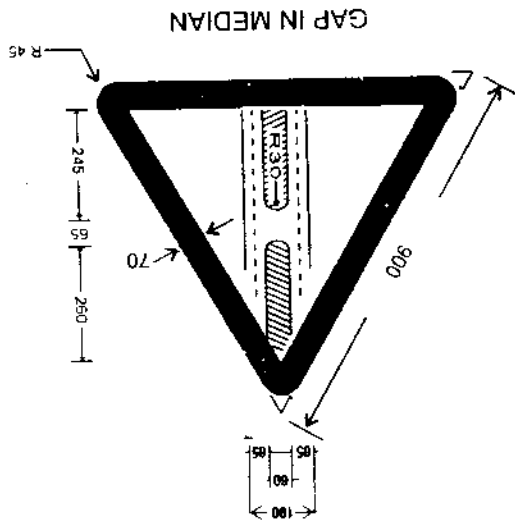

Fig. 14.5
 NARROW BRIDGE

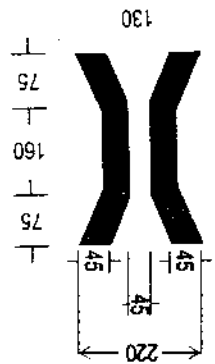

Fig. 14.6
 NARROW ROAD

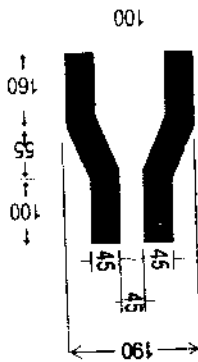

Fig. 14.7
 ROAD WIDENS

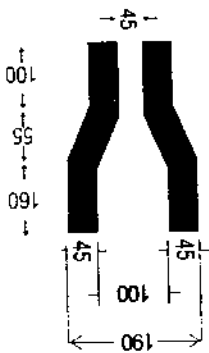
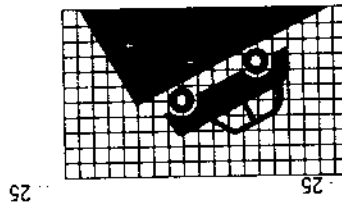
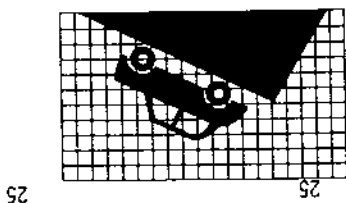

Fig. 14.4

STEEP ASCENT



STEEP DESCENT



1. Dimensions shown are for normal sized signs
2. All dimensions are in millimetres

Fig. 14.15
MEN AT WORK

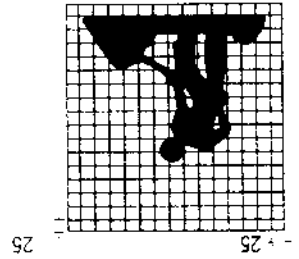

Fig. 14.16
FALLING ROCKS

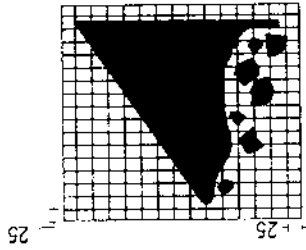

Fig. 14.17
FERRY

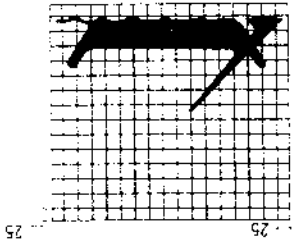

Fig. 14.11
CYCLE CROSSING

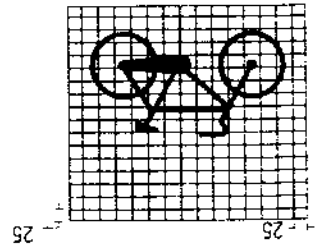

Fig. 14.12
PEDESTRIAN
CROSSING

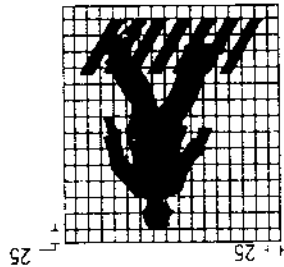

Fig. 14.13
SCHOOL

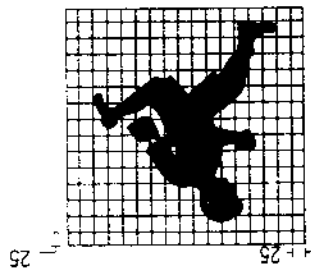

Fig. 14.14
CATTLE

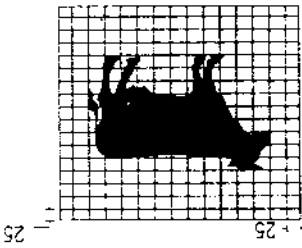

Fig. 14.9
SLIPPERY ROAD

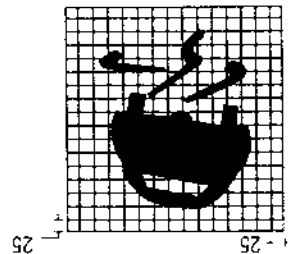
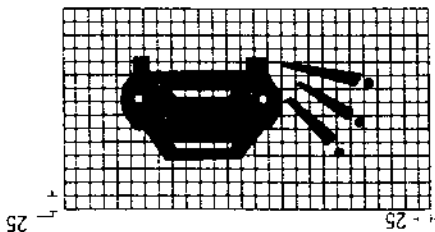

Fig. 14.10
LOOSE GRAVEL



1. Dimensions shown are for normal sized signs
 2. All dimensions are in millimetres

Fig. 14.22 STAGGERED INTER-SECTIONS

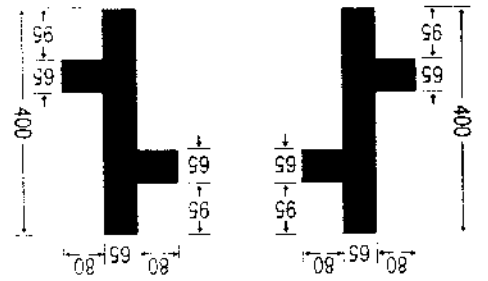

Fig. 14.23 MAJOR ROAD

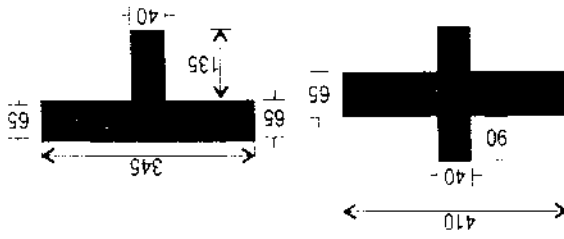

Fig. 14.24 ROUND ABOUT

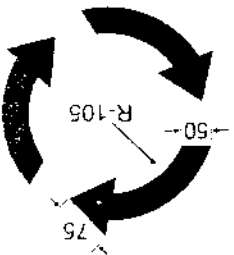

Fig. 14.21 Y-INTER-SECTION

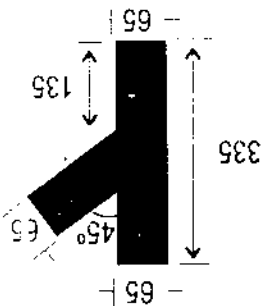
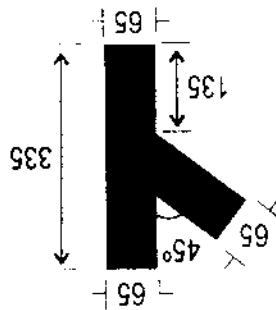
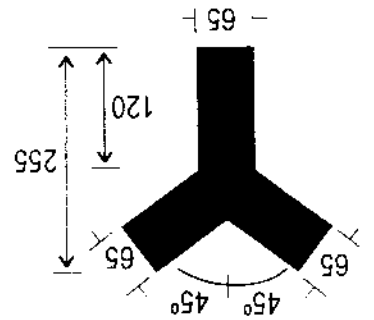

Fig. 14.18 CROSS ROAD

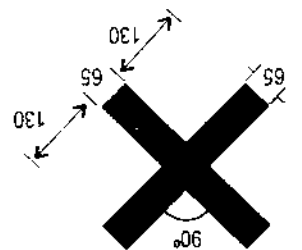

Fig. 14.19 SIDE ROAD

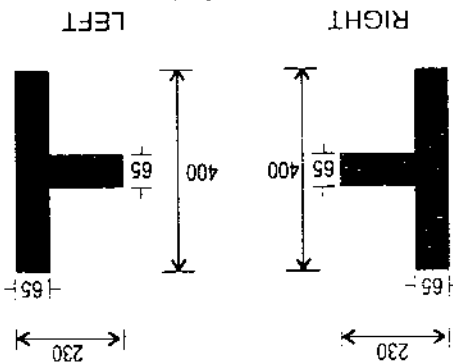
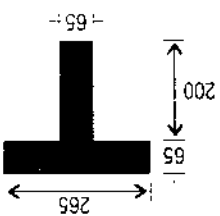

Fig. 14.20 T-INTER-SECTION



- 1. Dimensions shown are for normal sized signs
- 2. All dimensions are in millimetres

Fig. 14.27

BARRIER
 (A DEFINITION PLATE MAY BE
 ATTACHED WITH THE SIGN INDICATING
 THE DISTANCE TO THE BARRIER AND
 ANY OTHER INSTRUCTIONS)

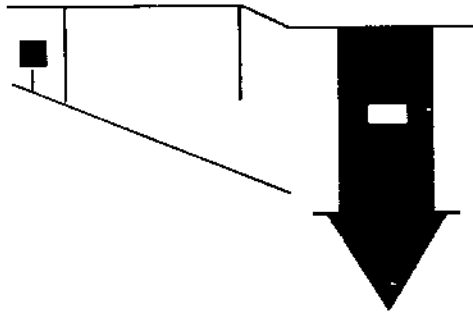

Fig. 14.26

RUMBLE STRIP

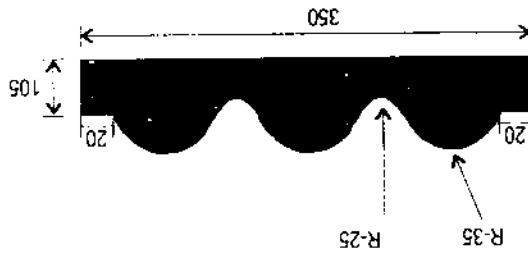
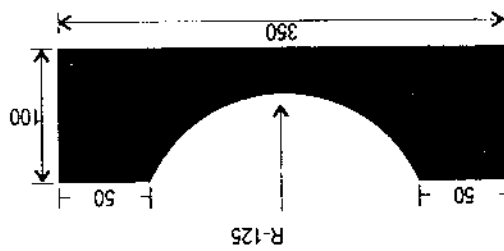

Fig. 14.25

DANGEROUS DIP



1. Dimensions shown are for normal sized signs
2. All dimensions are in millimetres

Fig. 14.29

GUARDED RAILWAY CROSSING
 (FOR EACH CROSSING, BOTH SIGNS ARE TO BE
 USED AT DISTANCES INDICATED ABOVE)

50-100 METRES IN HILLY TERRAIN
 200 METRES IN PLAIN & ROLLING
 TERRAIN AND 30-60 METRES IN
 HILLY TERRAIN

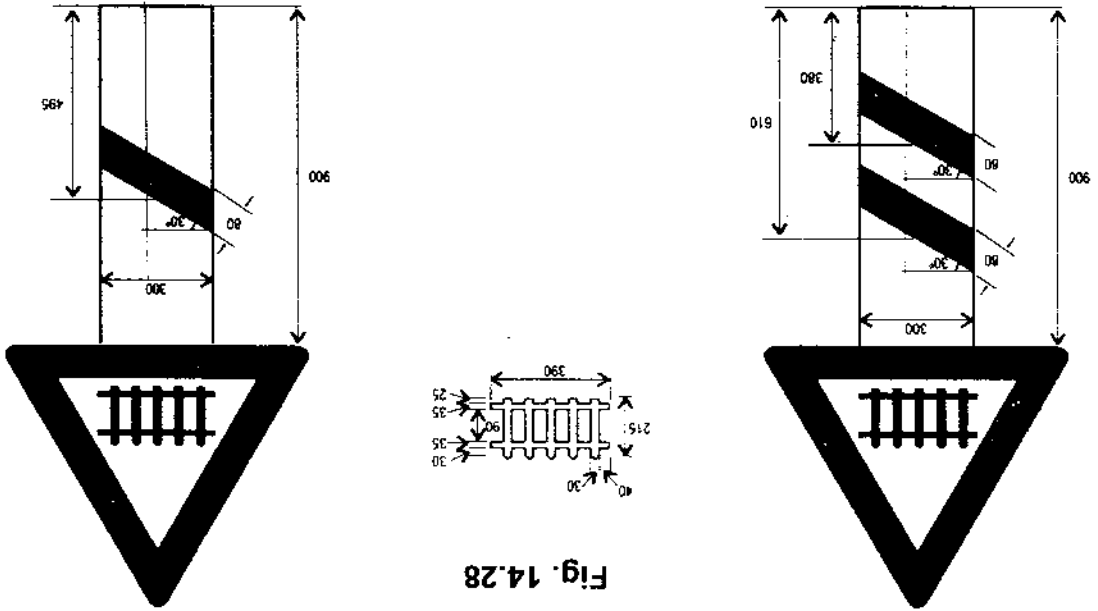

Fig. 14.28

UNGUARDED RAILWAY CROSSING
 (FOR EACH CROSSING, BOTH SIGNS ARE TO BE
 USED AT DISTANCES INDICATED ABOVE)

50-100 METRES IN HILLY TERRAIN
 200 METRES IN PLAIN & ROLLING
 TERRAIN AND 30-60 METRES IN
 HILLY TERRAIN

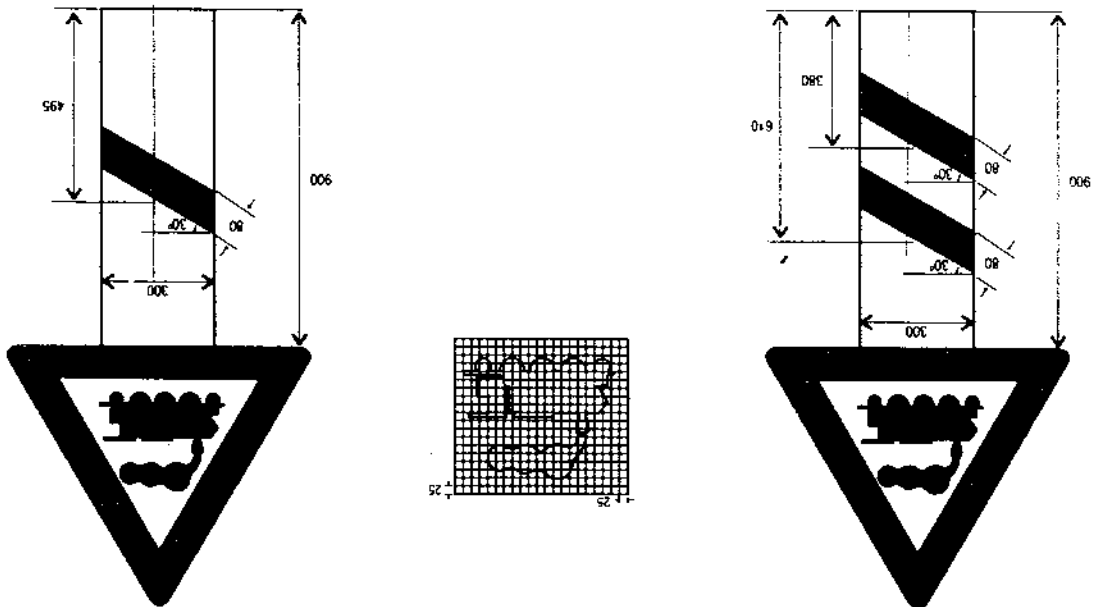

Fig. 14.32
RUN-WAY

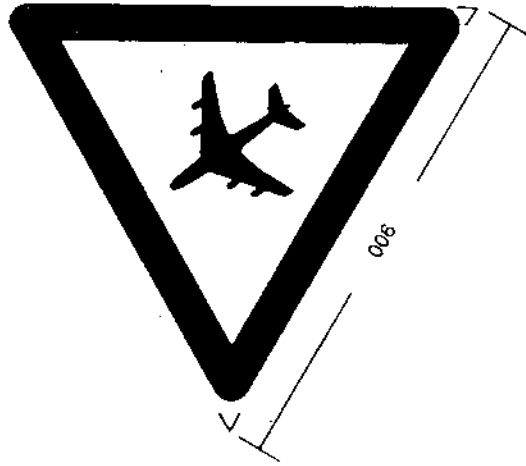

Fig. 14.31
TRAFFIC SIGNAL

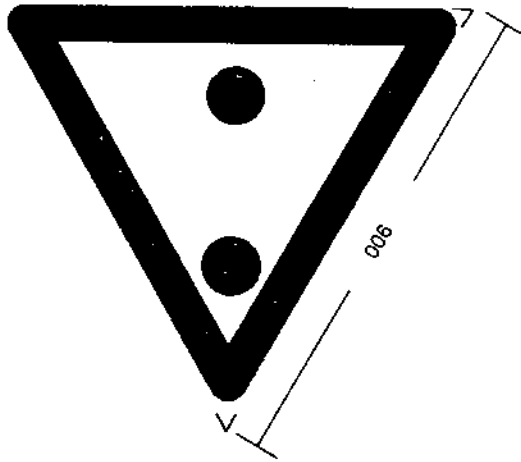

Fig. 14.30
SPEED BREAKER

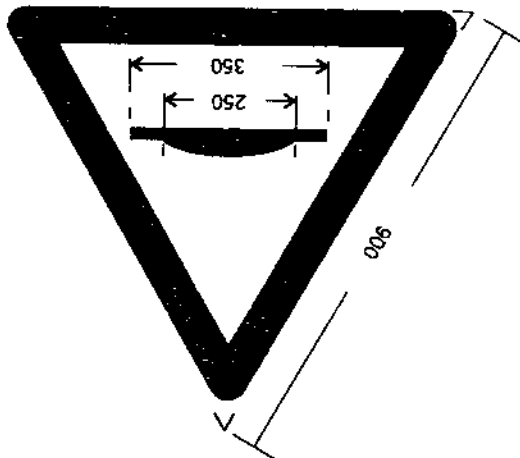

Fig. 14.35
SERIES OF BENDS

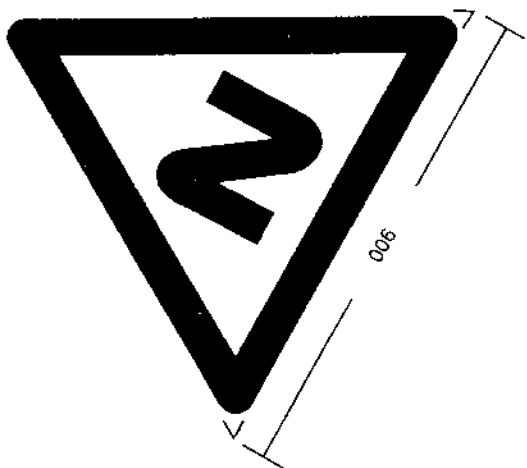

Fig. 14.34
START OF DUAL CARRIAGEWAY

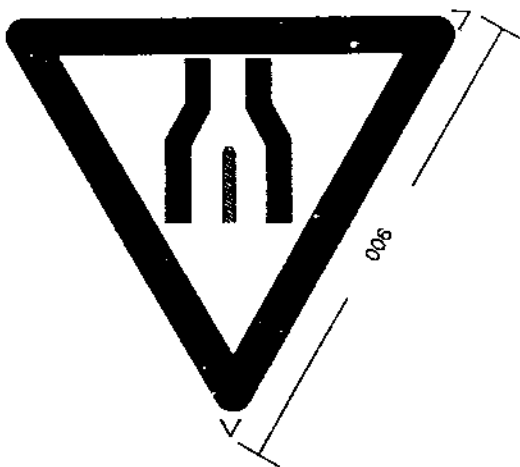

Fig. 14.33
END OF DUAL CARRIAGEWAY

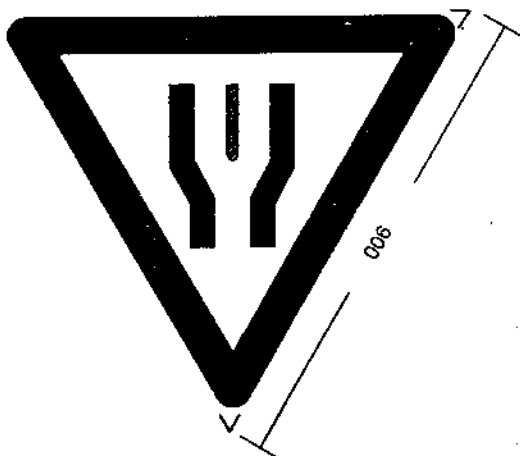

Fig. 14.38

QUAYSIDE OR RIVER BANK



Fig. 14.39

TWO-WAY TRAFFIC

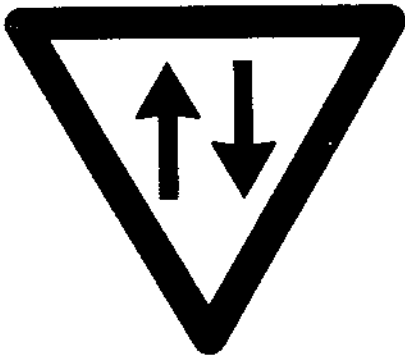

Fig. 14.36

DIVERSION TO THE OTHER CARRIAGEWAY
OF DUAL CARRIAGEWAY ROAD

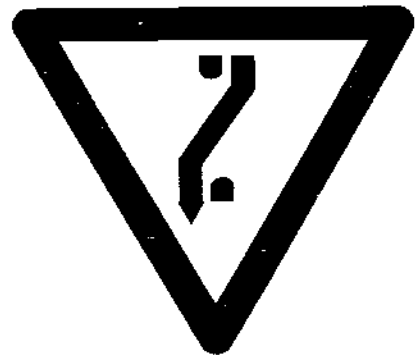

Fig. 14.37

OVERHEAD CABLE

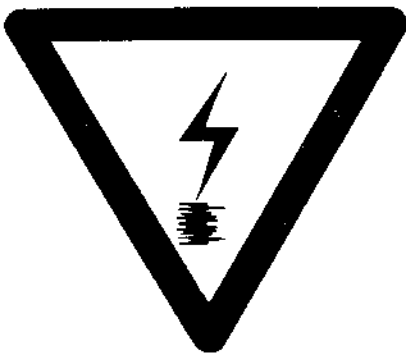

Fig. 14.40 (c)

LANE CLOSED (FOUR LANE ROAD)

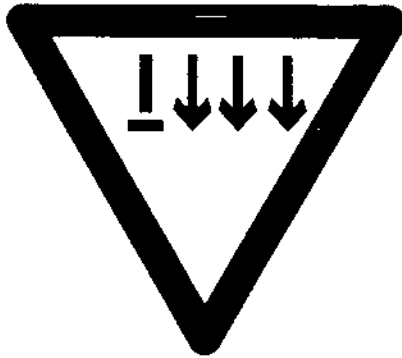

Fig. 14.40 (b)

LANE CLOSED (THREE LANE ROAD)

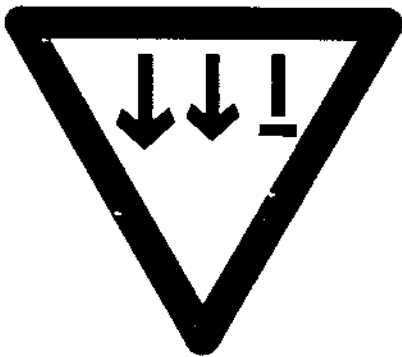
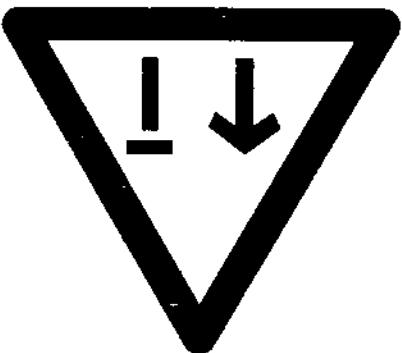
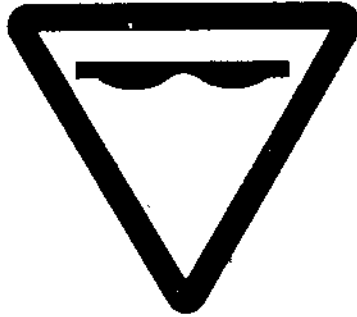

Fig. 14.40 (a)

LANE CLOSED (TWO LANE ROAD)



ROUGH ROAD
Fig. 14.43



REDUCED CARRIAGEWAY
Fig. 14.42

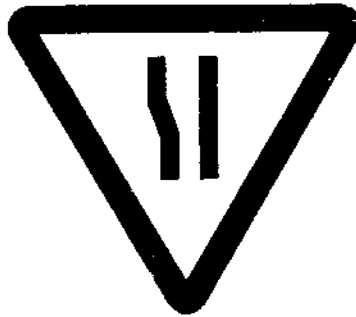

SUDDEN SIDE WINDS
Fig. 14.41

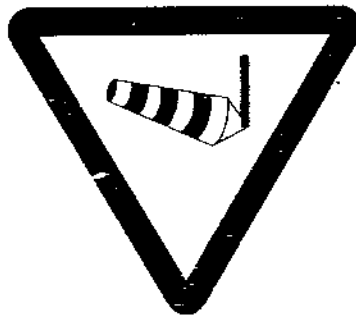

IN CASE OF FACILITY INFORMATION SIGNS, THE SIZE OF THE RECTANGLE SHALL BE 80 CM X 60 CM FOR NORMAL SIZED SIGN AND 60 CM FOR SMALL SIZED SIGN. THE SIZE OF THE SQUARE SHALL BE 40 CM AND 40 CM RESPECTIVELY. THE SIZE OF THE SYMBOLS SHOWN IS FOR NORMAL SIZED SIGN AND IN CASE OF SMALL SIZED SIGN, THE SYMBOL SHOULD BE THREE-FOURTH OF THE SIZE SHOWN.

INFORMATORY SIGNS

PLATE-3

Fig.15.1

ADVANCE DIRECTION / DESTINATION SIGN



DIRECTION AND PLACE IDENTIFICATION SIGNS

MAP TYPE ADVANCE DIRECTION SIGN

Fig.15.2

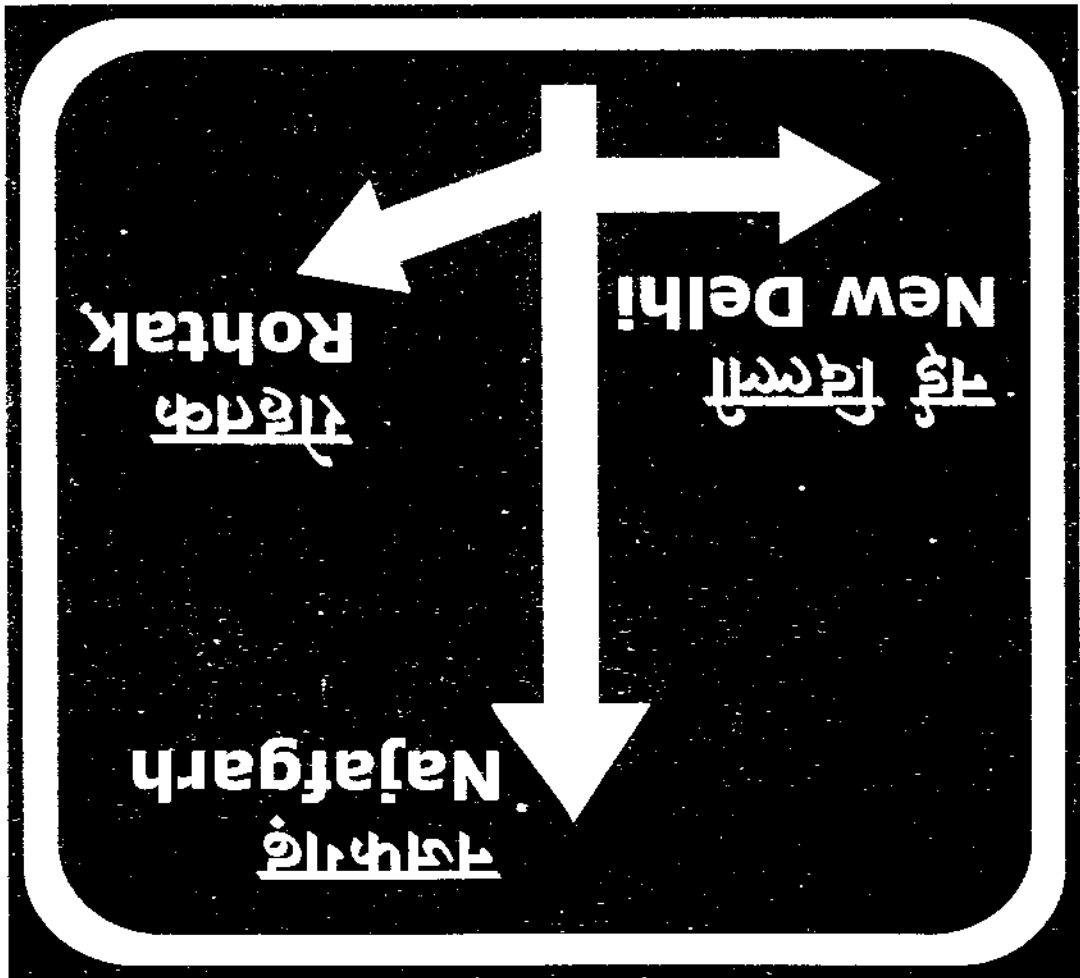

DIRECTION SIGN
Fig.15.4



ADVANCE DIRECTION SIGN ON ROTARY INTER-SECTION
Fig.15.3

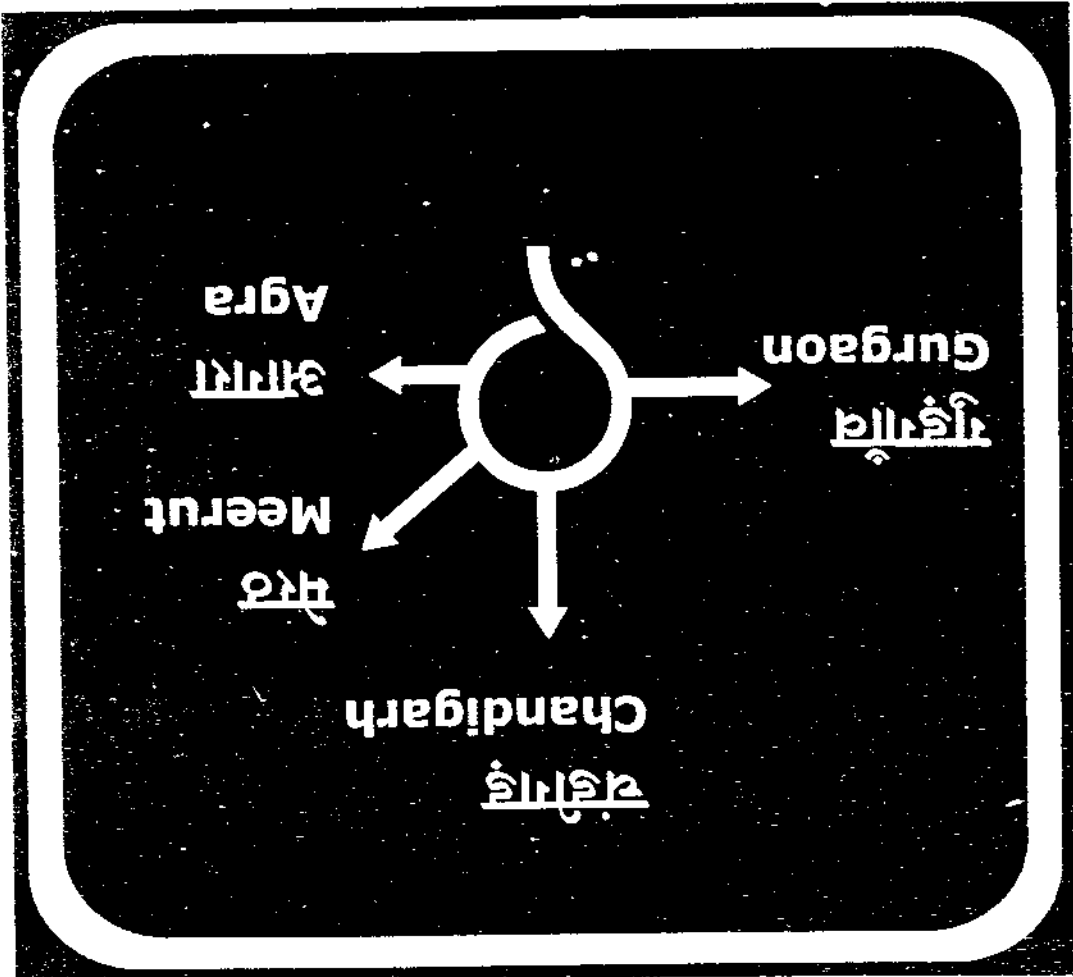

Fig.15.5
DIRECTION SIGN

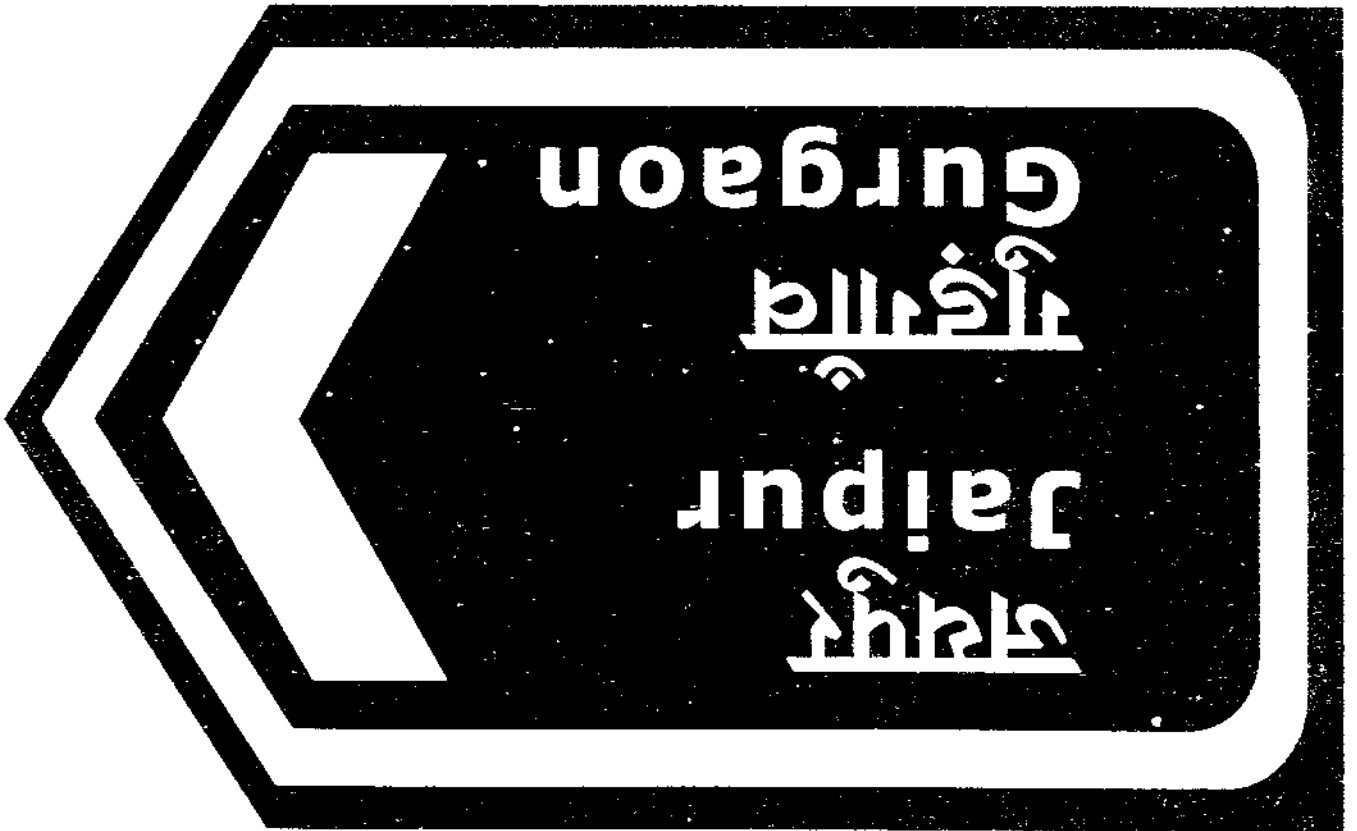

Fig.15.7

PLACE IDENTIFICATION SIGN



Fig.15.6

REASSURANCE SIGN



Fig 15.9
TOLL BOOTH AHEAD



Fig.15.8
TRUCK LAY BYE



FACILITY INFORMATION SIGNS

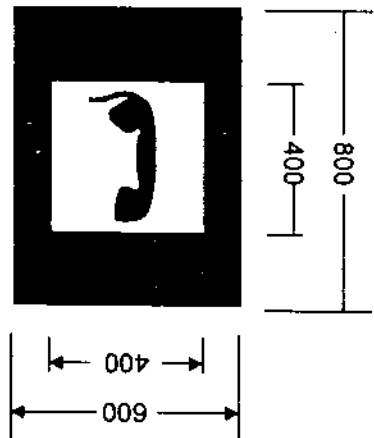

PUBLIC TELEPHONE

Fig. 15.10

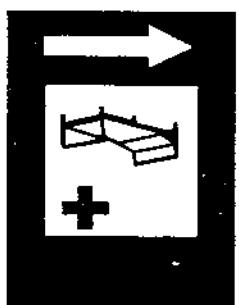

Fig. 15.12

EATING PLACE

Fig. 15.14



FILLING STATION

Fig. 15.11



FIRST-AID POST

Fig. 15.13

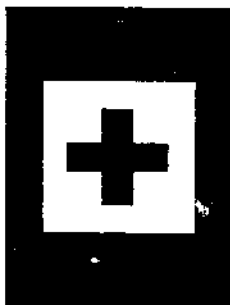

LIGHT REFRESHMENT

Fig. 15.15



1. Dimensions shown are for normal sized signs
2. All dimensions are in millimetres

OTHER USEFUL INFORMATION SIGNS

PLATE-3
(Continued)



Fig. 15.16
RESTING PLACE

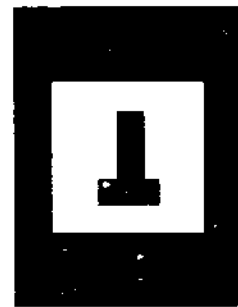
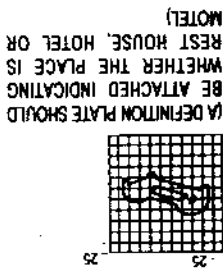

Fig. 15.17
NO THROUGH ROAD

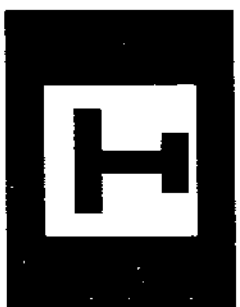
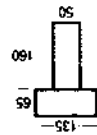

Fig. 15.18
NO THROUGH SIDE ROAD

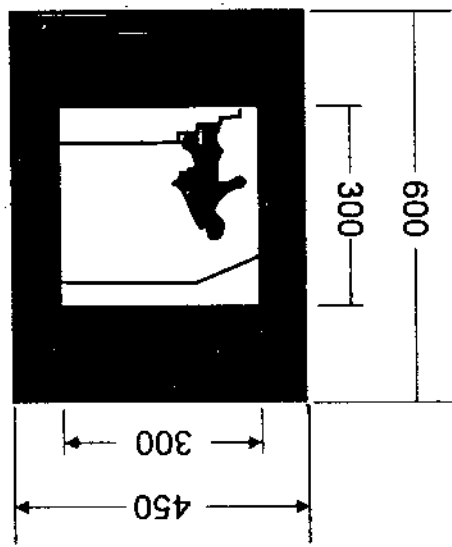
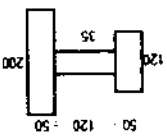

Fig. 15.19
PEDESTRIAN SUBWAY

1. Dimensions shown are for normal sized signs
2. All dimensions are in millimetres

POLICE STATION
Fig. 15.22



RAILWAY STATION
Fig. 15.23

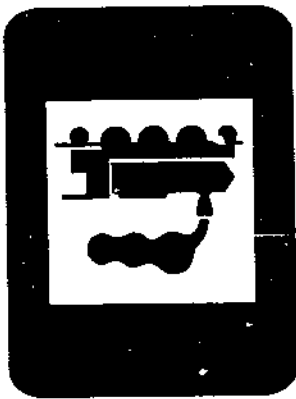

AIRPORT
Fig. 15.20



REPAIR FACILITY
Fig. 15.21



(b) BUS LANE
Fig. 15.24

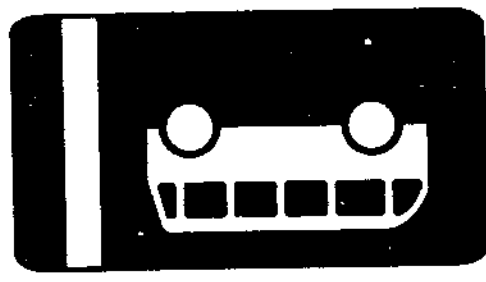

(a) CONTRA-FLOW BUS LANE

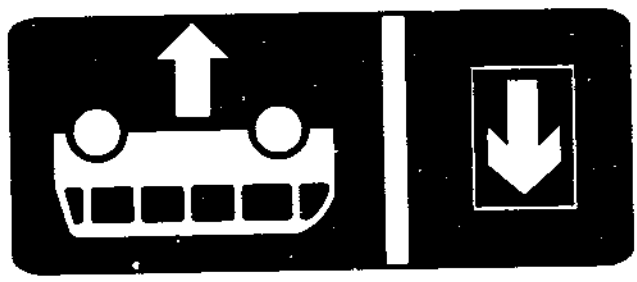

CYCLE-RICKSHAW STAND
Fig. 15.28

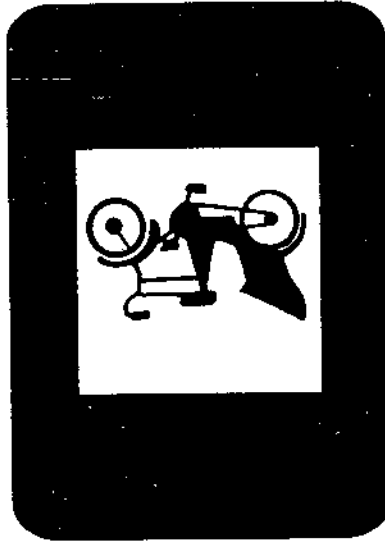

AUTO-RICKSHAW STAND
Fig. 15.27



TAXI STAND
Fig. 15.26

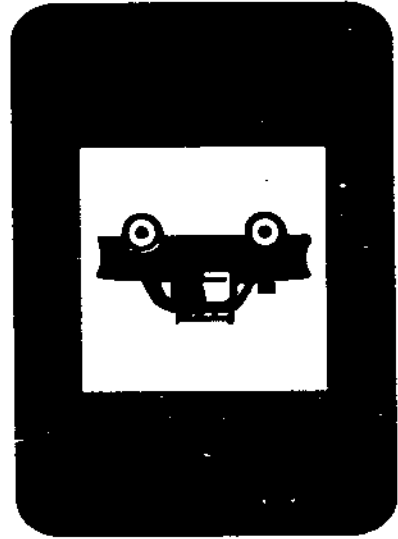

BUS STOP
Fig. 15.25

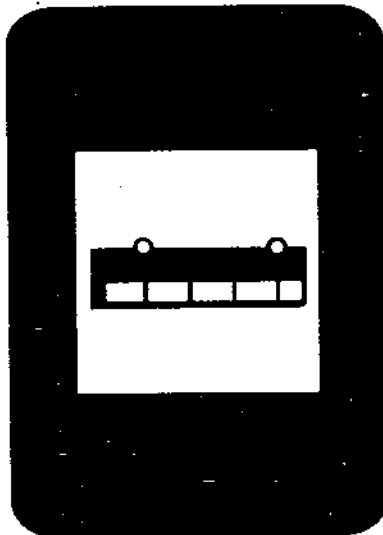

PARKING SIGNS

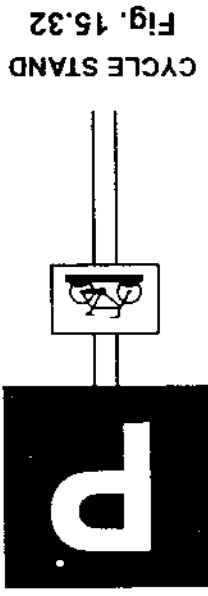
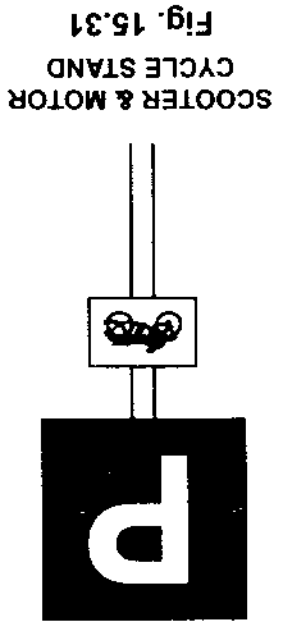
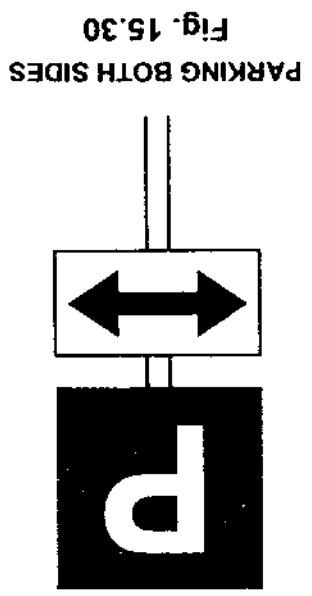
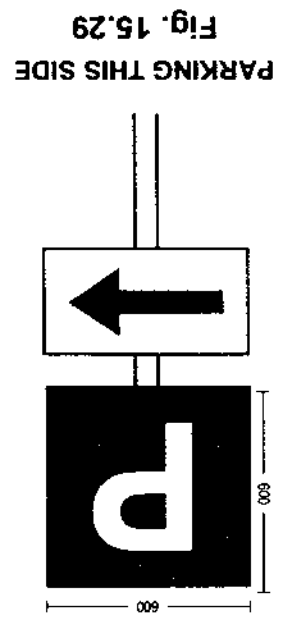

1. Dimensions shown are for normal sized signs
2. All dimensions are in millimetres

1. Dimensions shown are for normal sized signs
2. All dimensions are in millimetres

CYCLE-RICKSHAW
STAND
Fig. 15.35

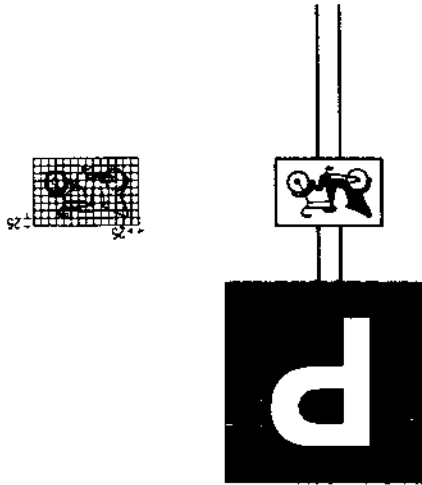

AUTO-RICKSHAW
STAND
Fig. 15.34

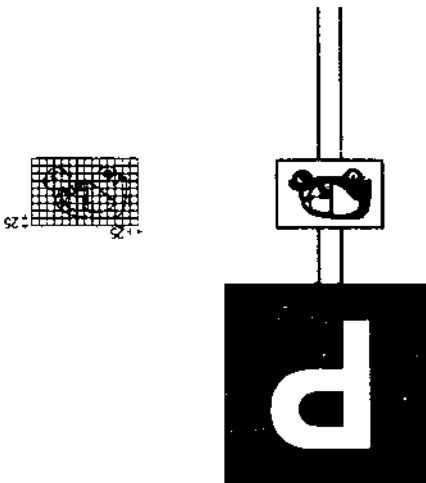

TAXI STAND
Fig. 15.33

